

# Sign Standards for Parking Facilities



**Montgomery County Maryland  
Division of Parking Management**

100 Edison Park Drive  
4th Floor  
Gaithersburg, Maryland 20878  
240-777-6000

**July 2009**



## Introduction

We are pleased to offer this guide for use in planning the application of exterior and interior graphics and signage to parking facilities located within Montgomery County.

This document has been evolving over the years since 2002 when the first edition was printed. It is one aspect of a much larger endeavor; communication through consistent quality design, of a community initiative.

Whether for a surface lot or parking structure, an effective visual communications system provides essential information to users of the facility as both drivers and pedestrians. Since the parking experience touches so many citizens and visitors, the graphics and signage actually illustrate the quality of life.

Award winning architectural design, superior landscaping, special attention to lighting issues and careful planning of each parking structure or surface lot can go unnoticed in a fast-paced community. But signs, although quite often taken for granted, must be viewed and followed, sometimes on a daily basis.

Our goal is simplification of the path, for the commuter, the shopper and the many visitors that form their impression of the County based on experiences along the way to their specific destinations.

When the path is easy and safe, the lasting impression is a positive product.

Jeremy Souders  
Planning Specialist III





| <b>Table of Contents</b> |                                   | <b>Page</b> |
|--------------------------|-----------------------------------|-------------|
| ID                       | Identity Signs                    | 3           |
| CE                       | Clearance / Entry Signs           | 4           |
| DR                       | Directional Signs                 | 5           |
| PW                       | Pedestrian Wayfinding             | 6           |
| PL                       | Plaque Signs for Codes            | 7           |
| CO                       | Cashier Operations                | 8           |
| MS                       | Multi-Space Operations            | 9           |
| PF                       | Pay on Foot Signs                 | 10          |
| RG                       | Regulatory Sign Types             | 11          |
|                          | Standard Typefaces                | 12          |
|                          | Standard Symbol Art               | 13          |
|                          | Color Coding Guide                | 14          |
|                          | Sign Programming                  | 15          |
|                          | Appendix of Sign Types - Drawings |             |
|                          | Specifications                    |             |





## Identity Signs

Those signs that identify a parking facility and make it visible from a distance, can also be the indication of an entrance to the facility from the street.

ID1 "P" sign cabinet - may be projecting double sided, internally illuminated to provide visibility from a distance



ID2 Sign Band - PUBLIC PARKING wall mounted, internally illuminated centered above vehicular entrances

ID3 The County Seal wall mounted adjacent the entrance, may be illuminated or dimensional

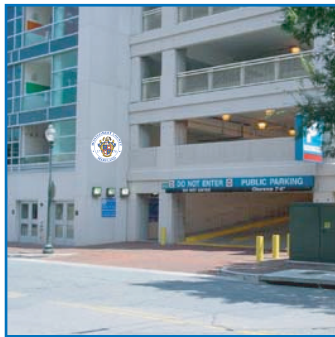

ID4 County Pylon sign standard freestanding, internally illuminated usually two sided, on concrete foundation provided by MCDOT

ID5 Panel Identity sign standard wall mounted adjacent entrances at facilities with limited frontage may be illuminated



While a uniform, consistent appearance is desired to project the corporate strength of County operations, designers are encouraged to customize signs to fit architectural conditions and coordinate with building profiles, landscaping details and other elements of the built environment.

All designs are subject to prior approval by MCDOT before fabrication and installation may take place.

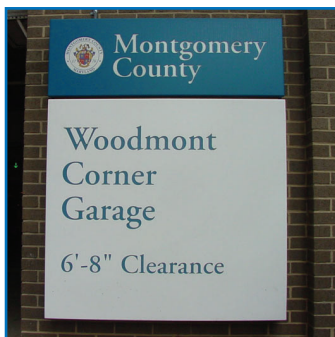

Refer to the Appendix of sign type drawings for further indication of sizes, colors and other details. Refer to County Sign Specifications for specific requirements prior to designing alterations to standard sign types.





## Clearance / Entry Signs

Entrances to parking facilities must communicate the low point of 'clearance' to prevent damage to vehicles and County property. Entrances and exits are often situated side-by-side and designation of the exit is important to prevent accidents.



CE1 Clearance Bar at entrance suspended by steel chain may be double sided, non-illuminated

CE2 DO NOT ENTER Bar at exit onto street suspended by steel chain may be double sided, non-illuminated



CE3 Caution Layout on Clearance or Exit Bar serves to warn drivers of pedestrian paths across parking entrances and exits

CE4 Green Arrow sign standard is wall mounted internally illuminated unit is centered above drive lane.

CE5 Red X sign standard is wall mounted internally illuminated unit is centered above drive lane.

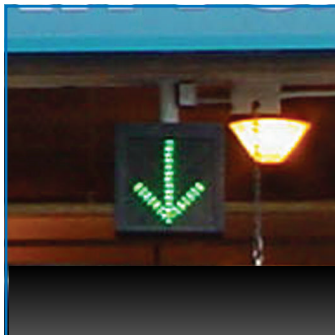

Refer to the Appendix of sign type drawings for further indication of sizes, colors and other details. Refer to County Sign Specifications for specific requirements prior to designing alterations to standard sign types.

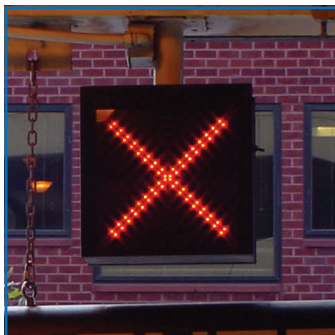



## Directional Signs

Directional signs with or without regulatory messages are the key to vehicular wayfinding through County parking facilities. Directional signs are not subject to design alteration as the consistent vernacular is essential to the smooth flow of traffic and safety of the customers.



**DR6** 6 Foot long signs are suspended from welded framework or mounted to beams in positions to take advantage of existing light.

**DR8** 8 Foot long signs are suspended from welded framework or mounted to beams in positions to take advantage of existing light.

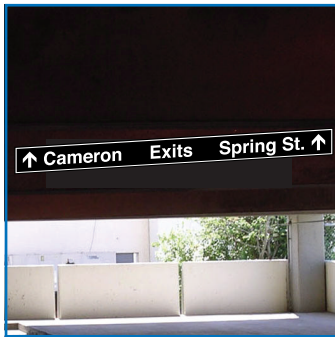

**DR10** 10 Foot long signs are suspended from welded framework or mounted to beams in positions to take advantage of existing light.

**DR12** 12 Foot "Welcome to" sign appears at entries with County Seal art and establishes overhead system at start.

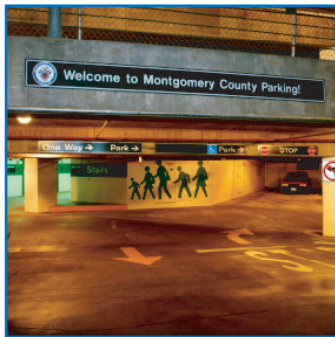

**DRX** Overhead signs which display pedestrian directions or employ color coding are a similar layout to other Directional signs. Signs are sized to fit special conditions.

Refer to Standard Symbol Art exhibit for details and color indications.



Refer to the Appendix of sign type drawings for further indication of sizes, colors and other details. Refer to County Sign Specifications for specific requirements prior to designing alterations to standard sign types.



## Pedestrian Wayfinding

After parking, customers are oriented and guided by color coded graphics that utilize column and wall surfaces to designate an area within a floor plan (rows) and elevator / stair cores around the perimeter. Color coding is consistent at all County parking venues.



PW1 Column row level designation expresses level and row on concrete columns between bays of parking. At minimum graphics are located at end of row.



PW2 2 Foot wide painted color band may include 12" lettering to label elevator and stair cores with name of street or other logical information or band can be painted solid color without lettering.



PW3 Supergraphic level designation is sized to fit walls at elevator lobbies and create a memorable landmark before pedestrians exit.

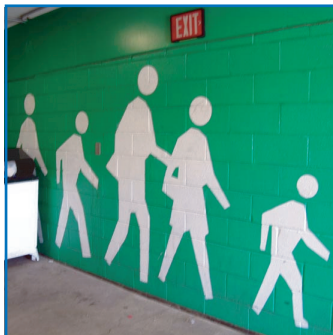

PW4 Supergraphic 'walking people' are enlargements of Pedestrian Crossing art to brighten key wall surfaces and create a memorable landmark before pedestrians exit.

PW5 Level on stair door is white film applied to doors which are painted in level designation colors.



All applications of painted graphics are protected from vandalism by a clear coatings applied to the top surface after final approval of the art by MCDOT representatives.

Refer to Appendix & Specifications for additional "PW" sign types available but consult MCDOT prior to adjusting layouts.



## Plaque Signs at Elevators & Stairs

Although the count of visually impaired customers is low, Montgomery County is dedicated to the spirit of ADA legislation and provides tactile copy and braille at stairs and other spaces where special wayfinding may be a need. Other plaque-type signs are placed to satisfy code requirements.

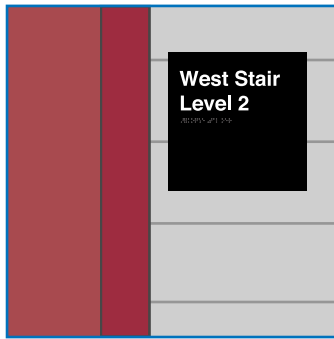

PL1 Rooms requiring tactile graphics, Stair & Level designation names at stairwells and floor and exit path marking. Plaques may be sized to accommodate message. Minimum copy 5/8".

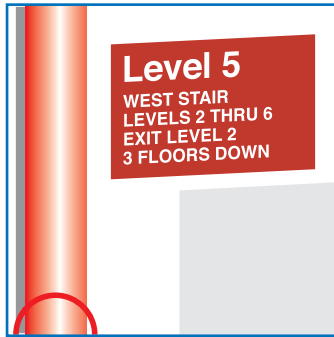

PL2 "Fire Marshall's Sign" plaque in stairs as required by County Code. This system endeavors to exceed requirements where practical.

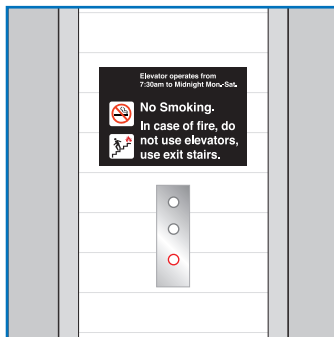

PL3 Elevator Plaque communicates exit information and smoking prohibition. Signs inside elevator cabs are to be provided by elevator company.

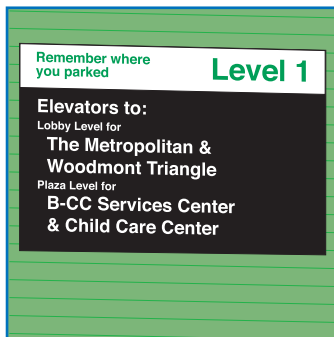

PL4 Wayfinding Information is displayed at a consistent size with PL3 as these units are generally seen in close proximity.

PL5 Accessible Route Marker identifies the path for disabled customers, where needed and may mark the Area of Rescue Assistance at a stair core.



Layouts vary. Copy fitting is intended to present a visually balanced appearance without cramming text onto a background.

Reducing text to fit is allowed. Condensing text to fit is discouraged. Follow letter spacing and sizing examples in the following Appendix of Sign Types for further guidance and direction.





## Cashier Operations Sign Types

Although the number of facilities with a cashier present is reduced and preference leans toward automated systems, several garages operate with booths and need designation of protocol and related messages displayed predominantly at entrance / exits.

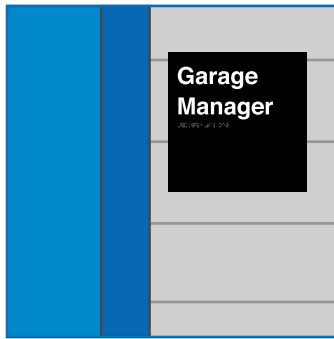

CO1 Similar to ADA plaques type PL this sign marks entrances to Manager's office at 5'-0" to center of plaque above floor, at strike side of door.

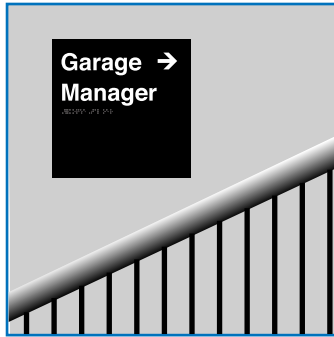

CO2 Is same as CO1 but includes an arrow at locations where the office entrance is not obvious and requires directions to guide customers.



CO3 Generally cashier operations are the facilities that include restrooms. An ADA plaque is provided at 5'-0" to center of plaque above floor, at strike side of door.

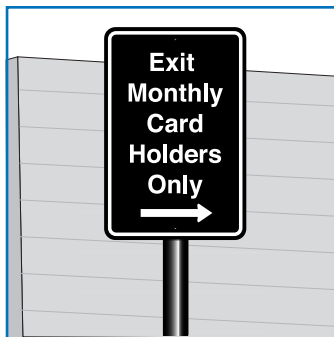

CO4 Lane designation panel is posted at garage exits, usually post mounted.

CO5 Contact Information is mounted at Cashier stations and other locations such as the Garage Manager's office.

Sign messages may appear in other sizes. Refer to the Appendix of Sign Types for further information, dimensions and specifications.

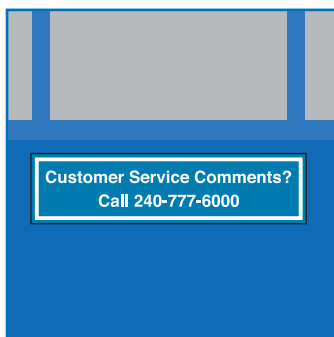

When programming a sign system for a new facility or renovation, provide a rough draft to MCDOT for discussion, comment and preliminary approval to avoid confusion and significant later revision.



## Multi-Space Operations (pay-by-space)

More County parking garages are converting to Multi-Space Operations where central pay stations are located and customers pay in advance before heading off toward their destination. Signs for these facilities are black & white or color coded depending on location.

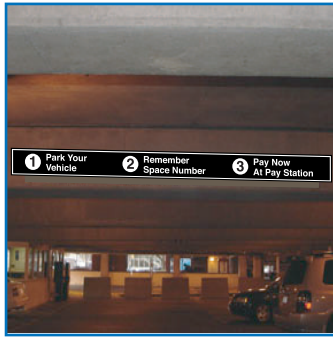

**MS1** Suspended overhead, consistent with parking garage directional signs and designed to fit within the directional sign system as a reminder of payment method.



**MS2** This is a column or wall mounted version of MS1 - re-proportioned to fit locations along the drive aisles or at garage pedestrian exits.



**MS3** Column or wall mounted reminder may be installed as a temporary measure where facilities 'switch-over' to new operation.

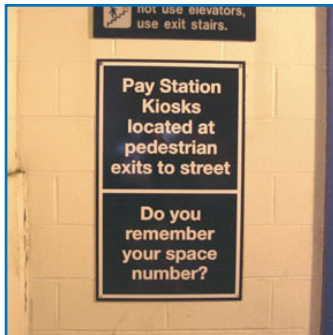

**MS4** Unit provides Pay Station Location and reminder regarding parking space number, needed to complete payment.

**MS5** Sign labels pay stations where machines are not visible or operation is not obvious.

Multi-Space signs should be placed in consistent positions and evenly spaced relative to direction and regulatory signs to present a balanced sequence of messages.

Avoid sign clutter by spacing messages at intervals which allow for recognition and provide a logical order of information.

Other Multi-Space sign types are presented in the Appendix of Sign Types. Pay Station manufacturers can offer guidance on programming sign locations.



## Pay on Foot Signs

Similar to Multi-Space Operations where central pay stations are located at entrances and exits but 'ticket based'. Signs for these facilities are all color coded to coincide with garage level designation per the larger sign standard. This system also employs the Helvetica Italic font.



PF1 Reminder painted on column may also be a digital print applied to painted surface. May work in conjunction with row designation.



PF2 Instruction panel appears at Pay Station locations, wall mounted to provide instruction to customers at multiple machines.



PF3 Mural graphic is painted on wall at Pay Stations or may be digital print applied to wall if surface is not accommodating. Conditions vary so design is essential to confirm dimensions.



PF4 Unit provides directions to Pay Station Locations and reminder regarding the need to pay before returning to vehicle.

PF5 Sign labels parking space dedicated to last minute payment for customers who cannot understand the system.



Pay on Foot signs should be placed in consistent positions and evenly spaced relative to direction and regulatory signs to present a balanced sequence of messages.

Other Pay on Foot sign types are presented in the Appendix of Sign Types. Pay Station manufacturers may offer guidance on programming sign locations.



## Regulatory Sign Types

Adaptations of signs from the MUTCD standards employ similar sizes and manufacturing but present a more uniform appearance through use of County Secondary Font: Arial Bold Condensed.



RG1 Handicapped parking space signs (3 messages) combined onto one panel to prevent sign clutter and simplify maintenance. Signs are centered on parking spaces, wall or post mounted.



RG2 Parking restrictions may appear in one, two or three hour increments. Refer to Appendix of sign types for other layouts.



RG3 PCS spaces are marked with single direction arrow at either end of row or as designated by MCDOT.

RG4 Carpool spaces may employ different hours for different facilities. STRICTLY ENFORCED message may not be required.

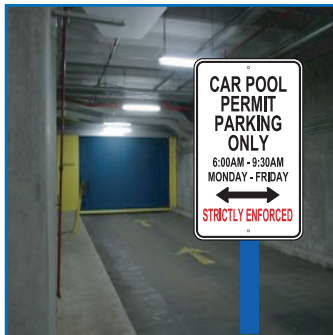

RG5 Bicycle Parking and Motorcycle Parking signs are similar and placement is determined by configuration of spaces. Usually wall mounted but post may be required.

Regulatory signs on exterior lots, post mounted, are positioned 7'-0" to bottom of sign. Signs within a parking garage may be placed lower to balance with wall and overhead beam conditions.



Other Regulatory sign types are presented in the Appendix of Sign Types. MCDOT will determine locations for restricted parking spaces and other situations requiring Regulatory Signs.



**ABCDEFGHIJKLMN  
OPQRSTUVWXYZ  
abcdefghijklmno  
pqrstuvwxyz  
1234567890**

## Standard Typefaces

Matching County Standard fonts is essential to the consistency and uniform patterns of parking sign systems, exterior and interior. Adobe® fonts are employed and layouts are available to sign company designers for purposes of replicating typography exactly.

### Primary Font: Helvetica Bold

Used on all sign bands and directional signs and pedestrian information signs.

**ABCDEFGHIJKLMN  
OPQRSTUVWXYZ  
abcdefghijklmno  
pqrstuvwxyz  
1234567890**

### Secondary Font: Arial Narrow Bold

Used on Regulatory signs and signs where volume of text requires a condensed layout.

**ABCDEFGHIJKLMN  
OPQRSTUVWXYZ  
abcdefghijklmno  
pqrstuvwxyz  
1234567890**

### Times Roman Bold

This font is used on the County standard freestanding pylon identity sign and wall mounted version only.

*ABCDEFGHIJKLMN  
OPQRSTUVWXYZ  
abcdefghijklmno  
pqrstuvwxyz  
1234567890*

### Helvetica Regular Italic

This font is used on the signs associated with the Pay on Foot systems.

Contact MCDPWT for specific font names and comparable substitutions if absolutely necessary. Refer to Specifications for indication of font product names and acquisition information.

Refer to Appendix & Specifications for specific requirements prior to designing alterations to standard sign types.





1 County Seal



2 Public Parking



3 No Ped. X-ing



4 Do Not Enter

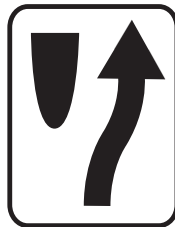

5 Keep Right



6 One Way



7 Stop



8 No Left Turn



9 Handicapped



10 HC Parking



11 Emergency Exit



12 No Smoking



13 Yield



14 Restrooms



15 Ped. X-ing



16 Ped. Feature



17 Marty Meter



Standard Arrow

## Standard Symbol Art

Symbols are employed on signs by inclusion in layouts and mention in the sign message schedule. Numbers appearing in the symbol column of the sign message schedule are cross-referenced with the symbols to the left.

Symbol art developed for MCDOT are not necessarily Department of Transportation standard. Lettering and borders have been altered to fit sign situations. Outline files of art are available for sign company and designer use in laying out sign systems for County facilities.

Symbols are precision cut from 2 mil. reflective film in colors shown and as indicated on sign drawings. A maximum of 2 layers of film is allowed when applying symbol art to sign faces.

Refer to drawings in Appendix for exact position of symbol art on sign face panel, and symbol relation to borders and typography.

Contact MCDOT for electronic files to be used in layouts. Refer to Specifications for indication of film product names and acquisition information.

Refer to drawings in Appendix for specific requirements prior to designing alterations to standard sign types.



## Level 6



Scotchcal Film No. 7725-38 (Royal Purple), Pantone 2685 C

## Level 5



Scotchcal Film No. 7725-41 (Dark Grey), Pantone Cool Grey 10

## Level 4



Scotchcal Film No. 7725-63 (Geranium), Pantone 193 C

## Level 3



Scotchcal Film No. 7725-29 (Russet Brown), Pantone 477 C

## Level 2



Scotchcal Film No. 7725-14 (Bright Orange), Pantone 158 C

## Level 1



Scotchcal Film No. 7725-46 (Kelly Green), Pantone 347 C

## Level G



Scotchcal Film No. 7725-47 (Intense Blue), Pantone 300 C

## Sign Backgrounds



Scotchcal Film No. 7725-12 (Black), Pantone Process Black

## Color Coding Guide

All color applications are subject to the approval of Montgomery County Division of Parking Management prior to application.

All paints, inks, acrylics and coatings are to be submitted prior to affecting materials. All samples are to be clearly marked with product name, product reorder number, date of submission, and name, address & phone number of contractor.

Facilities of 8 levels or more repeat the pattern of color application going upward. So Level 7 is Blue, Level 8 is Green, Level 9 is Orange, etc. **DO NOT MATCH COLORS FROM PRINTED EXAMPLES.**

Contact MCDOT for electronic files to be used in layouts. Refer to Specifications for indication of film product names and acquisition information.

Directional Sign Lettering, Reg. Sign Background



Scotchlite Film No. 280-10 Reflective White

Pedestrian Crossing Symbol Background

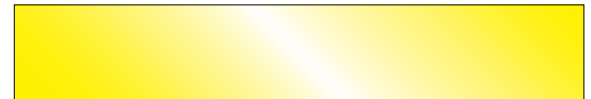

Scotchlite Film No. 280-71 Reflective Yellow

HC Symbol Background



Scotchlite Film No. 280-76 Reflective Blue

Regulatory Symbol Backgrounds - Stop, Yield etc.



Scotchlite Film No. 280-72 Reflective Red



### Sign Programming

Sign Programming is the placement of signs on garage or parking lot floor plans in a sequence of numbers to key back to a Sign Message Schedule so that sign locations can be viewed, checked and approved by MCDOT prior to fabrication and installation.

These plans also facilitate installation of the signs by the Sign Contractor and serve archive purposes for County sign maintenance over the years.

As in any architectural project, each plan should appear on a standard size sheet with a title block identifying the site with address, name and project name. Contact information and submission dates are provided in the title block, along with sheet numbers and dates of revision if there are changes after final approval of the project for fabrication.

Sign locations are indicated in red circles and sequential numbers starting with 01, 02 etc. appear in white helvetica bold on the circles. Leader lines in red may be used to prevent conflict with numbers and architectural lines.

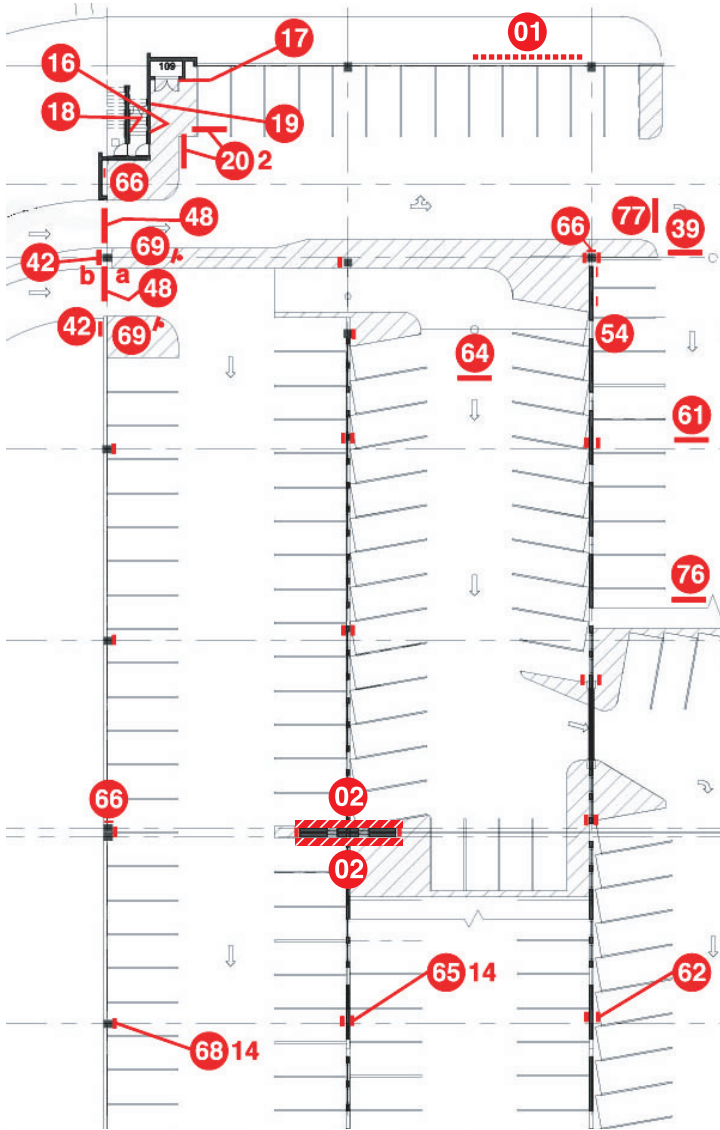

| 1ST FLOOR SIGNS |      |     |  |     |   |
|-----------------|------|-----|--|-----|---|
| No.             | Type | Sym | Message  | Qty | Note  |
| 01              | ID2  |     | PUBLIC PARKING   | 1   | Wall Mounted Internally Illuminated, Elec. Permit Required at Install               |
| 02              | PW2  |     | Old Georgetown Road  | 2   | Painted Supergraphics Blue band, white letters anti-graffiti coating                |
| 03              | PL1  |     | 1ST FLOOR<br>1 STAIR #1<br>FLOORS 1 - 6<br>EXIT LEVEL 3<br>2 FLOORS UP | 1   | Wall mounted inside stair with raised copy & Grade II Braille verify exact location |
| 04              | PL1  |     | 1 STAIR #1   | 1   | Wall mounted outside stair with raised copy & Braille verify exact location         |
| 05              | DRX  |     | Elevators / Stair #1   | 2   | Hanger Mount - Blue Field   |
| 06              | PL1  |     | 1ST FLOOR<br>STAIR #2  | 1   | Wall mounted outside stair with raised copy & Braille                               |
| 07              | PL7  |     | P104<br>ELEC<br>Authorized Personnel Only                              | 1   | Mounted on door non-tactile   |
| 08              | PL1  |     | 1ST FLOOR<br>1 STAIR #2<br>FLOORS 1 - 6<br>EXIT HERE                   | 1   | Wall mounted inside stair with raised copy & Grade II Braille verify exact location |
| 09              | PL1  |     | 1 STAIR #2   | 1   | Wall mounted outside stair with raised copy & Braille verify exact location         |
| 10              | DRX  |     | Stair #2   | 2   | Hanger Mount - Blue Field   |
| 11              | PL1  |     | 1ST FLOOR<br>STAIR #3  | 2   | Wall mounted outside stair with raised copy & Braille                               |
| 12              | PW2  |     | PARKING<br>1ST FLOOR   | 2   | Painted Supergraphics Blue band, white letters                                      |

Dotted lines are used to indicate signs with power requirements (illuminated) and diagonal white lines across a red band indicate painted super-graphics locations, particularly where a painted band may 'wrap' a wall surface for several yards.

The sign message schedule is created as an Excel® spreadsheet with columns for; Sign No., Sign Type, Symbols, Message, Quantity and Notes for each unit on each floor. Sign units which are identical may employ the same number. MCDOT can share example projects and work with programmers to match the standard for submissions.





### Identity Signs

|     |                             |
|-----|-----------------------------|
| ID1 | "P" Sign Cabinet            |
| ID2 | PUBLIC PARKING Sign Band    |
| ID3 | The County Seal             |
| ID4 | Identity Pylon Freestanding |
| ID5 | Identity Panel Wall Mounted |
| ID6 | Display of Rates at Entries |

### Clearance / Entry Signs

|     |                               |
|-----|-------------------------------|
| CE1 | Clearance Bar with dimensions |
| CE2 | Do Not Enter Bar at exit lane |
| CE3 | Caution / Slow for Ped Xing   |
| CE4 | Green Arrow at entries        |
| CE5 | Red X at exit lanes           |

### Directional Signs

|      |                                   |
|------|-----------------------------------|
| DR6  | 6 foot long directional sign      |
| DR8  | 8 foot long directional sign      |
| DR10 | 10 foot long directional sign     |
| DR12 | 12 foot long directional sign     |
| DRx  | directional sign alternate layout |

### Pedestrian Wayfinding

|     |                                  |
|-----|----------------------------------|
| PW1 | Row / Level Designation          |
| PW2 | Painted Band, Orientation        |
| PW3 | Level Number Super-Graphic       |
| PW4 | Lobby Landmark People            |
| PW5 | Level Number on Stair Door       |
| PW6 | Elevator/Stair Metal Panel       |
| PW7 | Level Number Metal Panel         |
| PW8 | Painted Metal Panel, Orientation |

### Plaque Sign Types

|      |                                   |
|------|-----------------------------------|
| PL1  | Stair / Level Designation         |
| PL2  | Fire Marshall's Sign in Stairs    |
| PL3  | Elevator Lobby Plaque             |
| PL4  | Wayfinding Information with color |
| PL5  | Elevator Cab Number labels        |
| PL6  | Accessible Route marking          |
| PL7  | Base Building Door Signs          |
| PL8  | Standpipe Marking                 |
| PL9  | Firemen's Receptacle Label        |
| PL10 | Area of Rescue Assistance sign    |

### Cashier Operations

|     |                              |
|-----|------------------------------|
| CO1 | Garage Manager's office sign |
| CO2 | Direction to Garage Manager  |
| CO3 | Restroom sign                |
| CO4 | Contact Information          |

### Multi-Space Operations

|     |                            |
|-----|----------------------------|
| MS1 | Overhead Instructions      |
| MS2 | Wall / Column Instructions |
| MS3 | Directional Reminder       |
| MS4 | Pay Station Location sign  |
| MS5 | Pay Station label          |
| MS6 | You Are Here map art       |
| MS7 | Freestanding Reminder      |

### Pay on Foot (take a ticket)

|     |                          |
|-----|--------------------------|
| PF1 | Reminder on Columns      |
| PF2 | Instruction Panel        |
| PF3 | Super-Graphic Mural      |
| PF4 | Directional Sign         |
| PF5 | Parking Space marker     |
| PF6 | Overhead Instructions    |
| PF7 | Changeable Message Frame |
| PF8 | Parking Designation      |

### Regulatory Signs

|      |                          |
|------|--------------------------|
| RG1  | HC Parking Standard      |
| RG2  | Parking Time Restriction |
| RG3  | Permit Parking sign      |
| RG4  | Car Pool sign with Hours |
| RG5  | Bike Space sign          |
| RG6  | No Parking Any Time      |
| RG7  | Recommended / Small Car  |
| RG8  | Use Crosswalk sign       |
| RG9  | 2-Wheel Parking Only     |
| RG10 | Scooters Only Decal      |

Sign systems are living changing entities which evolve and grow as conditions change at each facility. Sign types may cross boundaries between identity and directional and regulatory information. Sign layouts are flexible and sign message sizes may be adjusted to facilitate copy fitting.

The goal of the sign system programming is to protect the safety of the public and satisfy the wayfinding needs of parking customers. Messages should be placed as needed and the designation of sign types can reflect the spirit of the sign type for purposes of each individual project.

Designers may propose custom solutions to sign situations remembering that a uniform consistent appearance is necessary but the Division of Parking Management may approve alterations in the interest of best function.



Projecting or wall mounted flat, internally illuminated parking identity cabinets and "FULL" signs to be installed on walls above garage entries with bottom of cabinet at minimum 10'-0" above finished grade.

Face panel(s) of "P" cabinet to be white translucent acrylic 1/4" thick #7420 or equal. Apply film "P" to face, prime & paint cabinet County standard Blue with acrylic polyurethane satin sheen finish, then peel film off to expose acrylic. "P" Cabinet is internally illuminated by concealed L.E.D. units as required for even illumination without shadows or hot spots.

Interior surfaces of "P" cabinet to be painted white-glossy finish. Power connections to be concealed within skirt over mounting bracket. Refer to County Sign Specifications for anchors to be installed.

Lower cabinet only installed when loop detector system is in use for car counting.

Face panel of lower cabinet to be plexiglass #2423 translucent red, matte finish to secure attachment of 8" tall white neon letters: "FULL" to be controlled on/off by remote system. All electrical connections to be concealed within extrusions. All j-boxes & transformers to be installed - concealed, remote & accessible.

Note: Units may be single or double sided. back side of single faced cabinets to have white reflective vinyl "p" on upper cabinet and word "park" in 8" tall centered on lower cabinet. submit layouts for both sides.

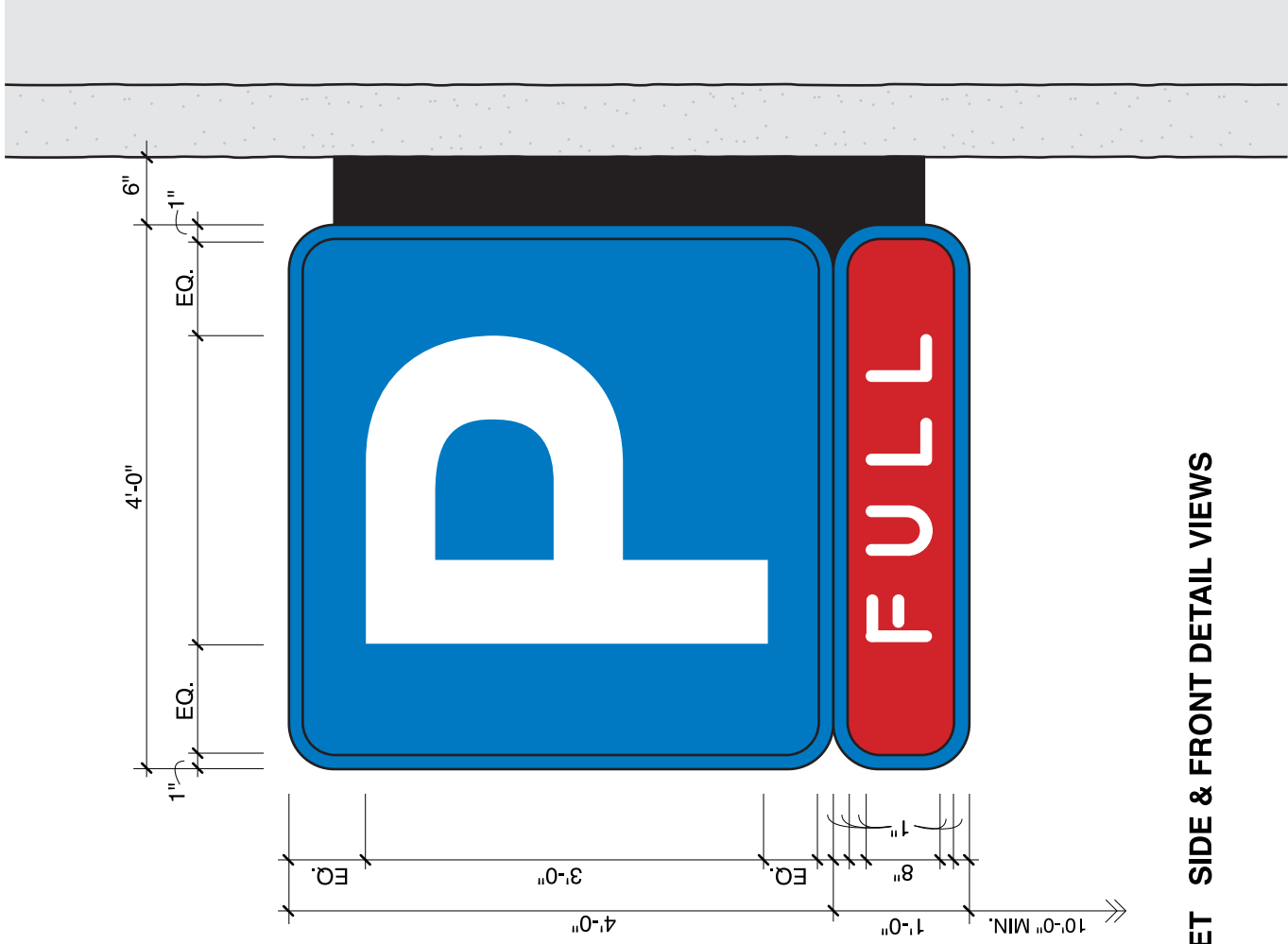

**ID1 - "P" SIGN CABINET SIDE & FRONT DETAIL VIEWS**

Scale: 3/4" = 1'-0"



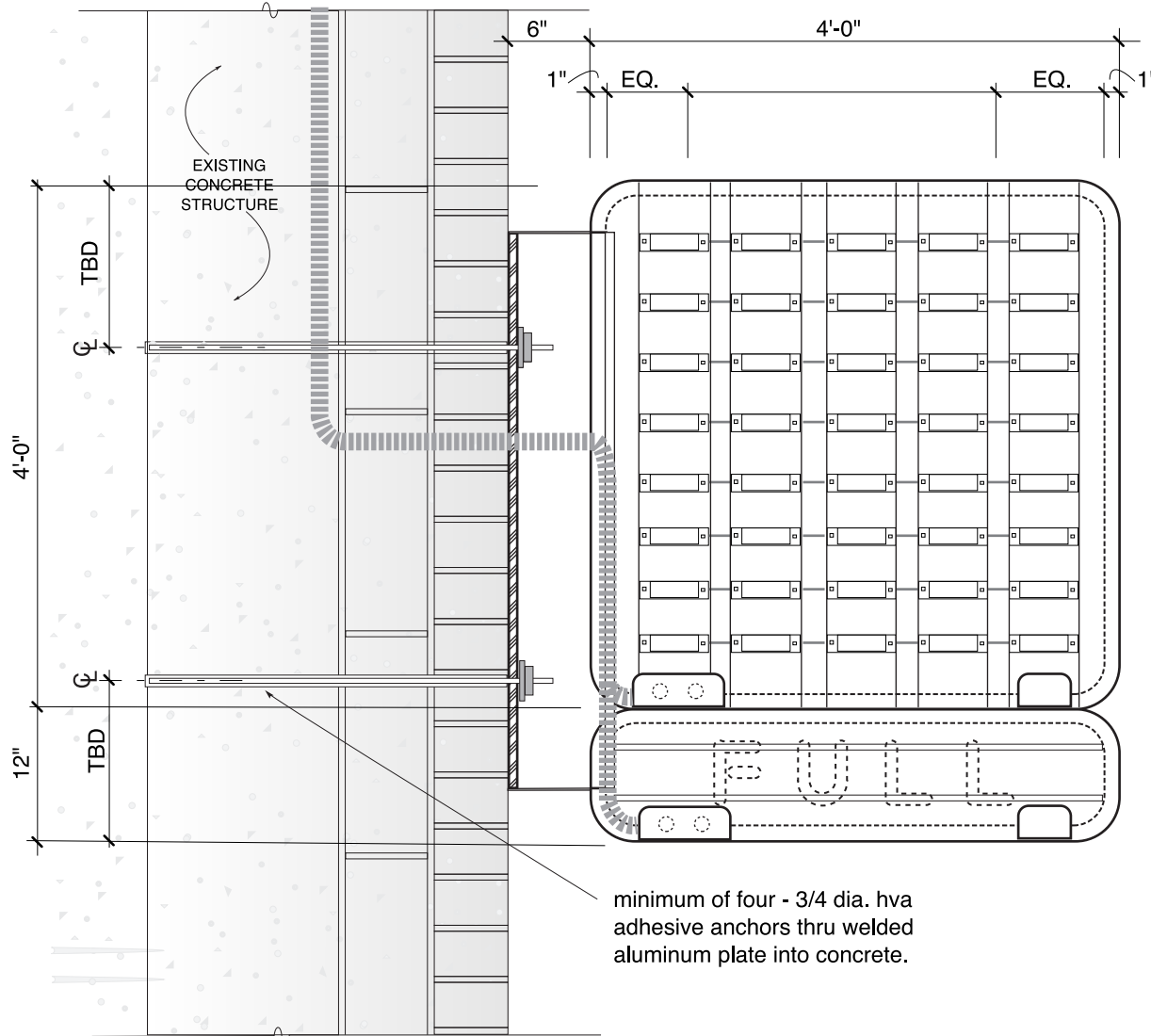

### ID1 - "P" SIGN CABINET SECTION AT MOUNTING

Scale: 3/4" = 1'-0"

Projecting or wall mounted flat, internally illuminated parking identity cabinets and "FULL" signs to be installed on walls above garage entries with bottom of cabinet at minimum 10'-0" above finished grade.

Face panel(s) of "P" cabinet to be white translucent acrylic 1/4" thick #7420 or equal. "P" Cabinet is internally illuminated by concealed L.E.D. units as required for even illumination without shadows or hot spots. Units may be ED12-CW Cool White Flex, pre-wired one module per foot by Electra LED, US-LED or equal.

Lighting test to be provided in shop for County approval prior to installation.

Interior surfaces of "P" cabinet to be painted white-glossy finish. Power connections to be concealed within skirt over mounting bracket. Refer to County Sign Specifications for anchors to be installed.

Lower cabinet only installed when loop detector system is in use for car counting. Face panel of lower cabinet to be plexiglass #2423 translucent red, matte finish to secure attachment of 8" tall white neon letters: "FULL" to be controlled on/off by remote system. All electrical connections to be concealed within extrusions. All j-boxes & transformers to be installed - concealed, remote & accessible.

If garage surface is brick, use caution in drilling to avoid spalling brick surface.



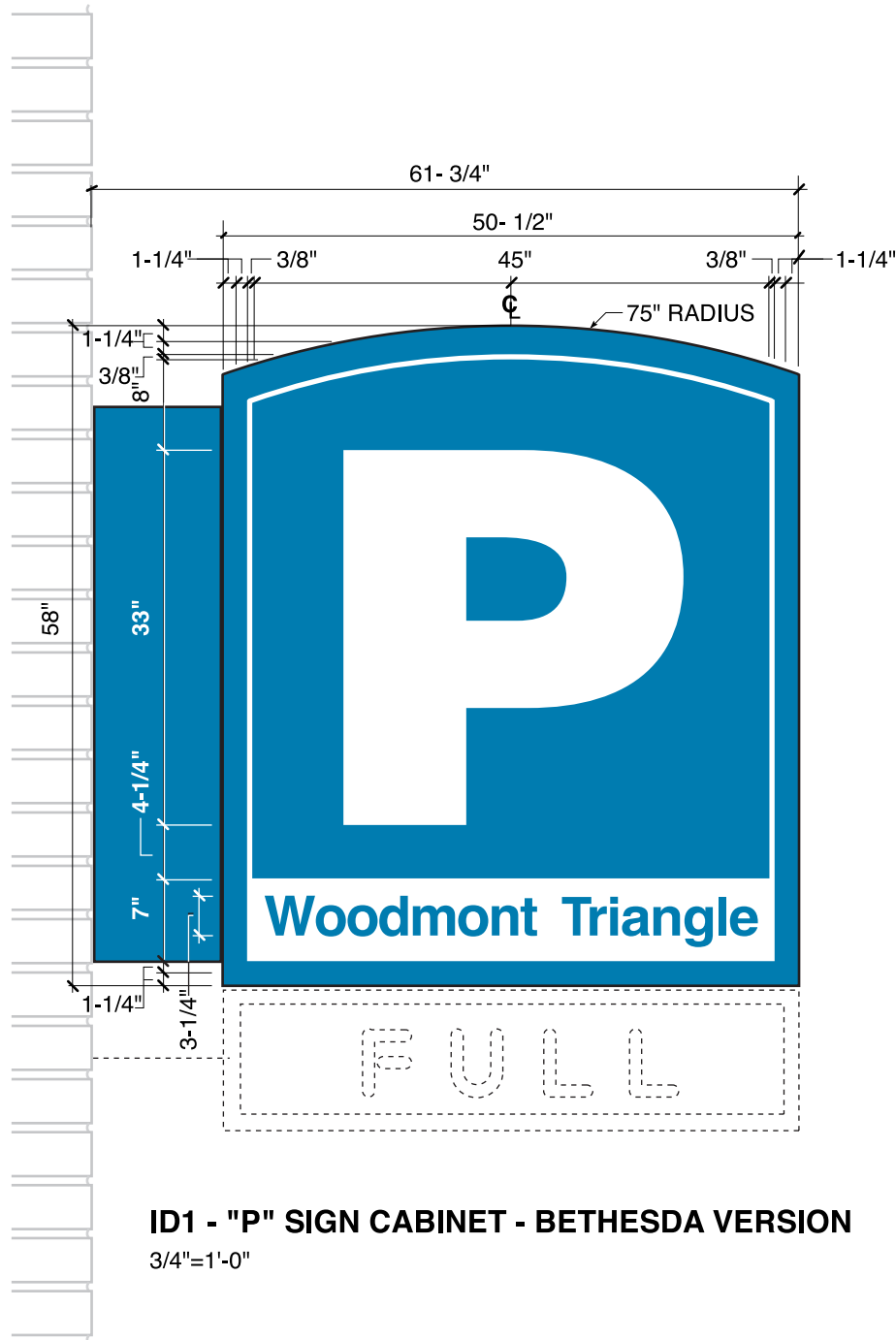

**ID1 - "P" SIGN CABINET - BETHESDA VERSION**

3/4"=1'-0"

For facilities located in Bethesda - projecting or wall mounted flat, internally illuminated parking identity cabinets "P" signs and "FULL" signs are to be installed on walls above garage entries with bottom of cabinet 10'-0" above finished grade.

This unit is designed and specifications are provided by the Bethesda Urban Partnership [BUP] for parking facilities within the downtown district of Bethesda only.

The lower cabinet is used to display the name of the parking facility in conjunction with downtown Bethesda wayfinding sign systems, installed by others.

Refer to Bethesda Urban Partnership sign standards for further dimensions, specifications, color applications and related notes.

Note: Units may be double sided. Sign contractor to provide proof of coordination with BUP and existing conditions at job site, relative to other sign locations prior to submission of shop drawings. This sign must be used at all Bethesda garages.

Refer to sign type ID1 page 17 and 18 for "full" sign specifications. "FULL" sign on Bethesda unit is painted same color as top cabinet and has squared corners to coordinate as shown.



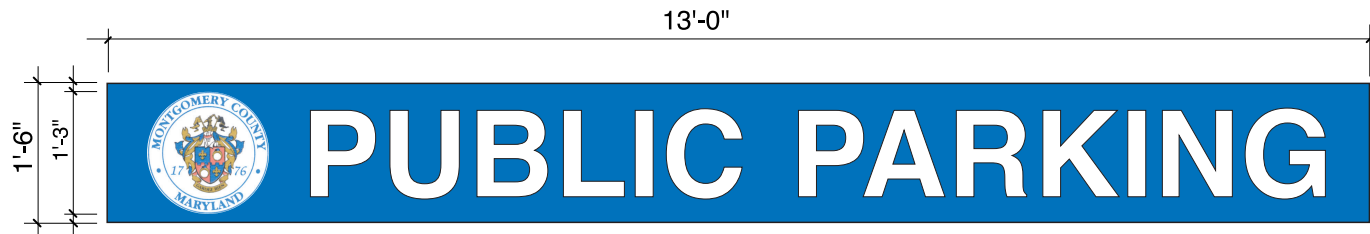

**ID2 - ALTERNATE LAYOUT INCLUDING COUNTY SEAL ART**

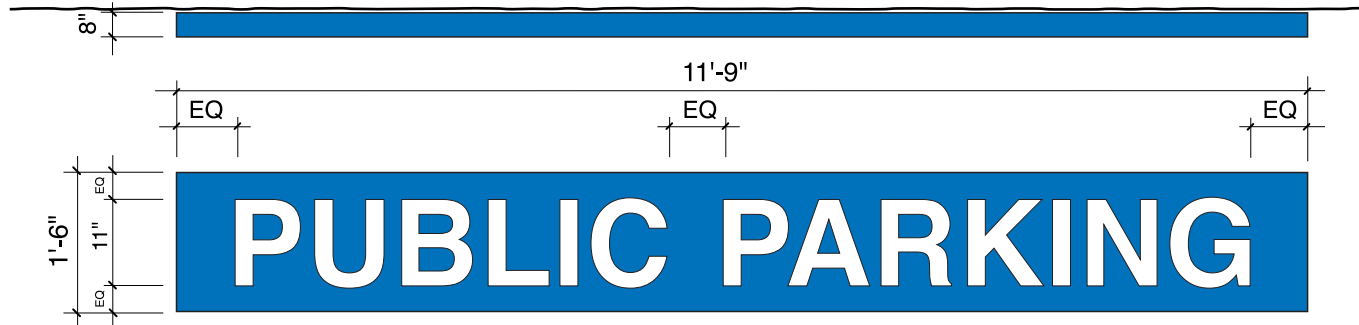

**ID2 - GARAGE ENTRANCE SIGN BAND LAYOUT & PLAN DETAIL TYPICAL**

Scale: 1/2" = 1'-0"

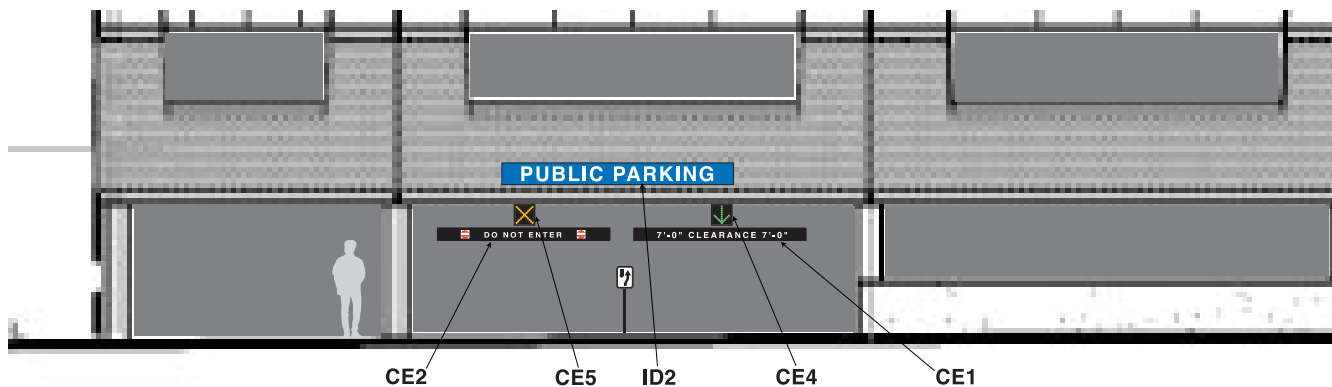

**ID2 SIGN BAND IN ELEVATION WITH RELATED ELEMENTS**

Not to Scale

8" deep internally illuminated sign band to have 1/4" face panel of white polycast acrylic, with translucent film background in blue to match county standard: Pantone 300c. Cabinets to be extruded aluminum with welded corners and welded aluminum tube framing as required for straight profiles.

All anchors to be stainless steel. Submit samples of all materials & finishes (12" sq. x 4) to MCDOT for approval prior to fabrication. Interior of cabinet surfaces to be primed and painted white with acrylic polyurethane, high gloss finish. Electrical connections at rear to coordinate with other power connections.

Internally illuminated sign cabinets to be lit by L.E.D. units: ED12-cw cool white flex, pre-wired one module per foot with SL-B scotch locks and heyclip 3893 with c2240-12 volt transformer by ElectraLED, Inc. [www.electraled.com](http://www.electraled.com) or equal. Cabinets to be shop tested. Confirm dimensions of as built conditions at job site prior to submission of shop drawings. Confirm relation of sign band with clearance bar assemblies and illustrate in section on shop drawings.

Sign contractor to provide shop drawings with engineer's seal for confirmation of elec. connection and structural mounting integrity. Sign contractor to obtain elec. permits for all illuminated signs, and transmit to MCDOT prior to installation. Provide wiring diagram for placement of l.e.d. units to ensure even illumination.



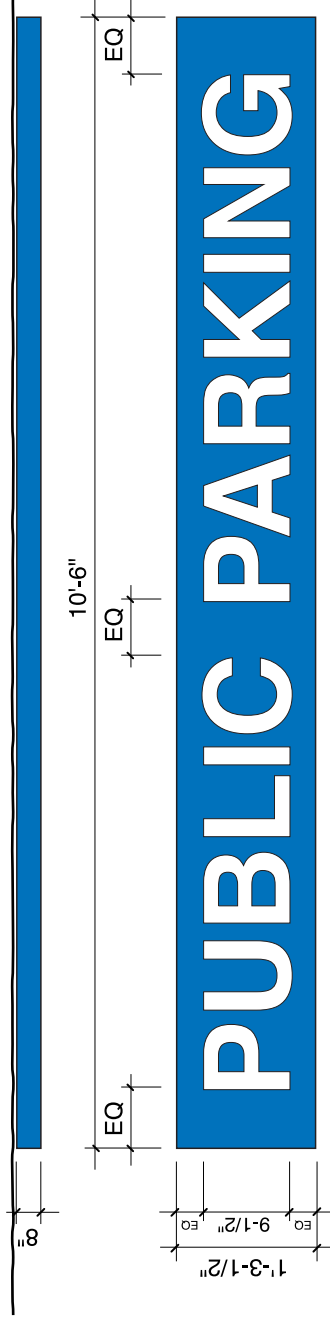

**ID2 - GARAGE ENTRANCE SIGN BAND LAYOUT & PLAN DETAIL TYPICAL**

Scale: 3/8" = 1'-0"

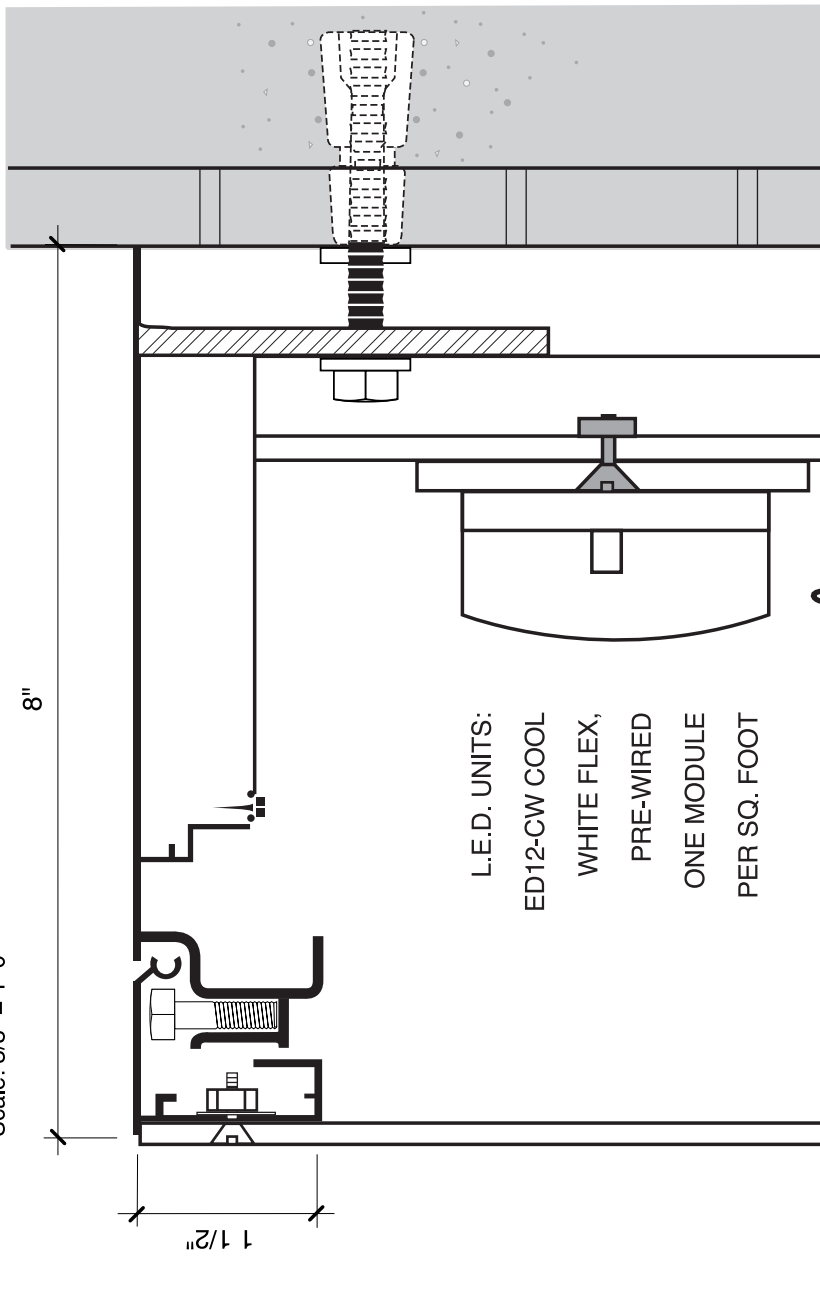

**ID2 - GARAGE ENTRANCE SIGN BAND SECTION DETAIL AT MOUNTING TYPICAL**

Scale: 3/4" = 1'-0"

8" deep internally illuminated sign band to have 1/4" face panel of white polycast acrylic, with translucent film background in blue to match county standard: Pantone 300c. Cabinets to be extruded aluminum with welded corners and welded aluminum tube framing as required for straight profiles.

All anchors to be stainless steel. Refer to MCDOT Specifications for indications of standard steel anchors and confirm attachment with Engineer's seal on shop drawing submissions. Imbedment of anchors is maximum 1" into concrete not including depth of brick veneers or other cladding found at jobsites.

Internally illuminated sign cabinets to be lit by L.E.D. units: ED12-cw cool white flex, pre-wired one module per foot with SL-B scotch locks and heyclip 3893 with c2240-12 volt transformer by ElectraLED, Inc. www.electraled.com or equal. Cabinets to be shop tested. Confirm dimensions of as built conditions at job site prior to submission of shop drawings. Confirm relation of sign band with clearance bar assemblies and illustrate in section on shop drawings.

Illuminated cabinets to have vents and weep holes as required to provide for drainage of condensation but all cabinets to be weatherproof to prevent corrosion and premature failure of electrical components.

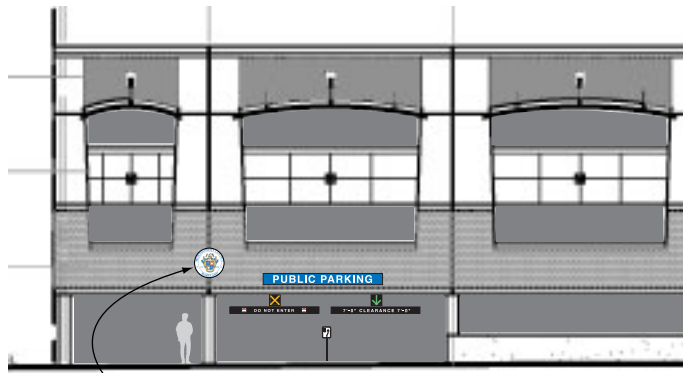

ID3 - COUNTY SEAL SIGN ON GARAGE FACADE - NTS

Projecting two-sided or single face wall mounted flat, internally illuminated County Seal cabinet signs to be installed on walls above garage entries with bottom of cabinet at minimum 10'-0" above finished grade. Verify exact locations with MCDOT.

Face panel(s) of cabinet to be white translucent polycarbonate 1/4" thick. Seal artwork to be digital print on clear film applied to face. Top layer of 3m™ 1160 UV Inhibitor Film applied over seal art to protect colors long term. MCDOT to provide artwork (not full size) in electronic form. Cabinets may be larger or smaller to fit architectural conditions. Larger art may be re-created if necessary to hold proper resolution.

Prime & paint sign cabinet and related stanchion assembly / escutcheon plates & hardware - white or County standard blue with acrylic polyurethane satin sheen finish on all exposed surfaces. Interior surfaces of cabinet primed & painted white. Cabinet is internally illuminated by concealed L.E.D. units as required for even illumination without shadows or hot spots.

Power connections to be concealed within mounting brackets and walls. Transformers or Junction Box units installed remote and accessible for servicing. Refer to County Sign Specifications for anchors to be installed.

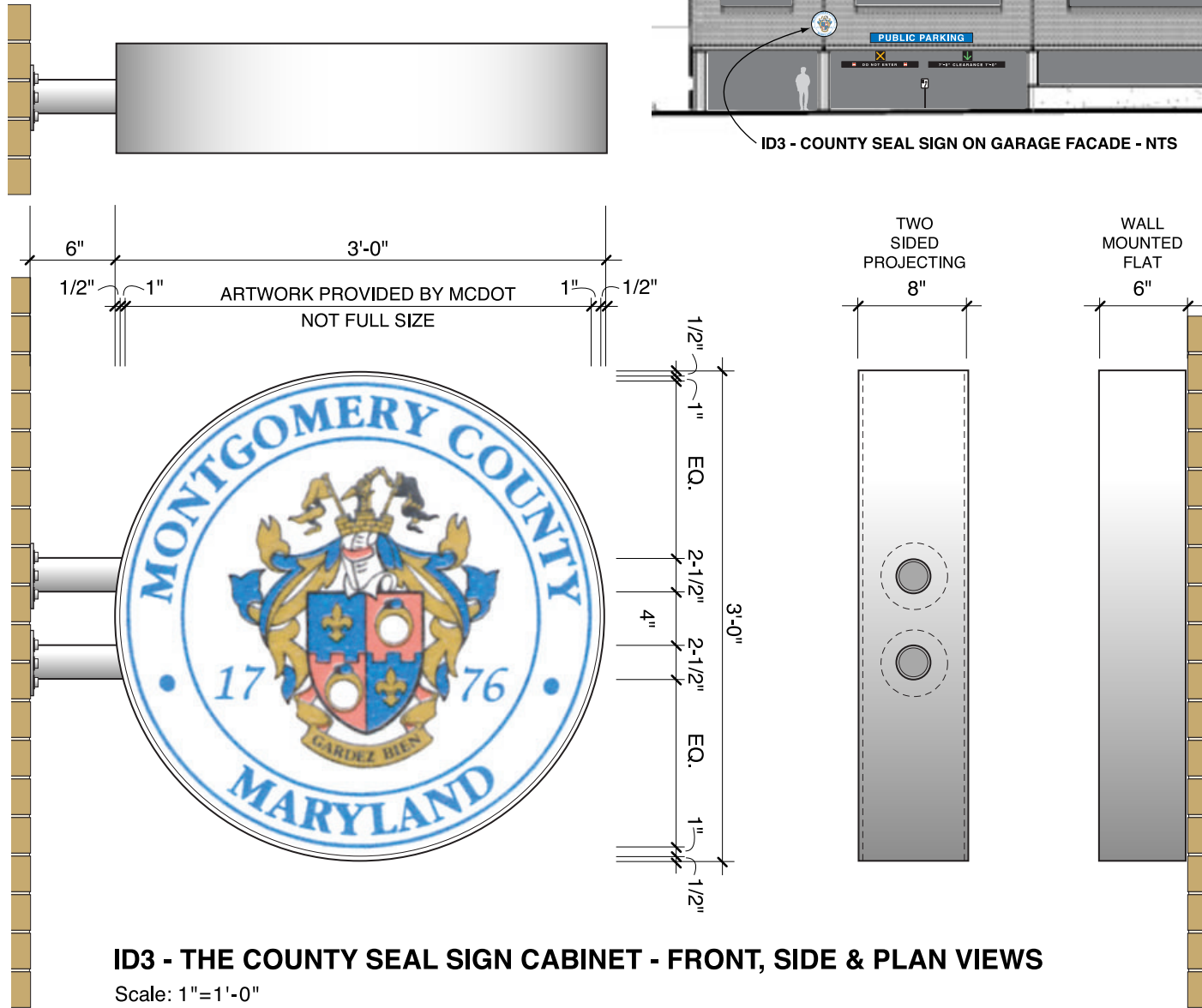

ID3 - THE COUNTY SEAL SIGN CABINET - FRONT, SIDE & PLAN VIEWS

Scale: 1"=1'-0"



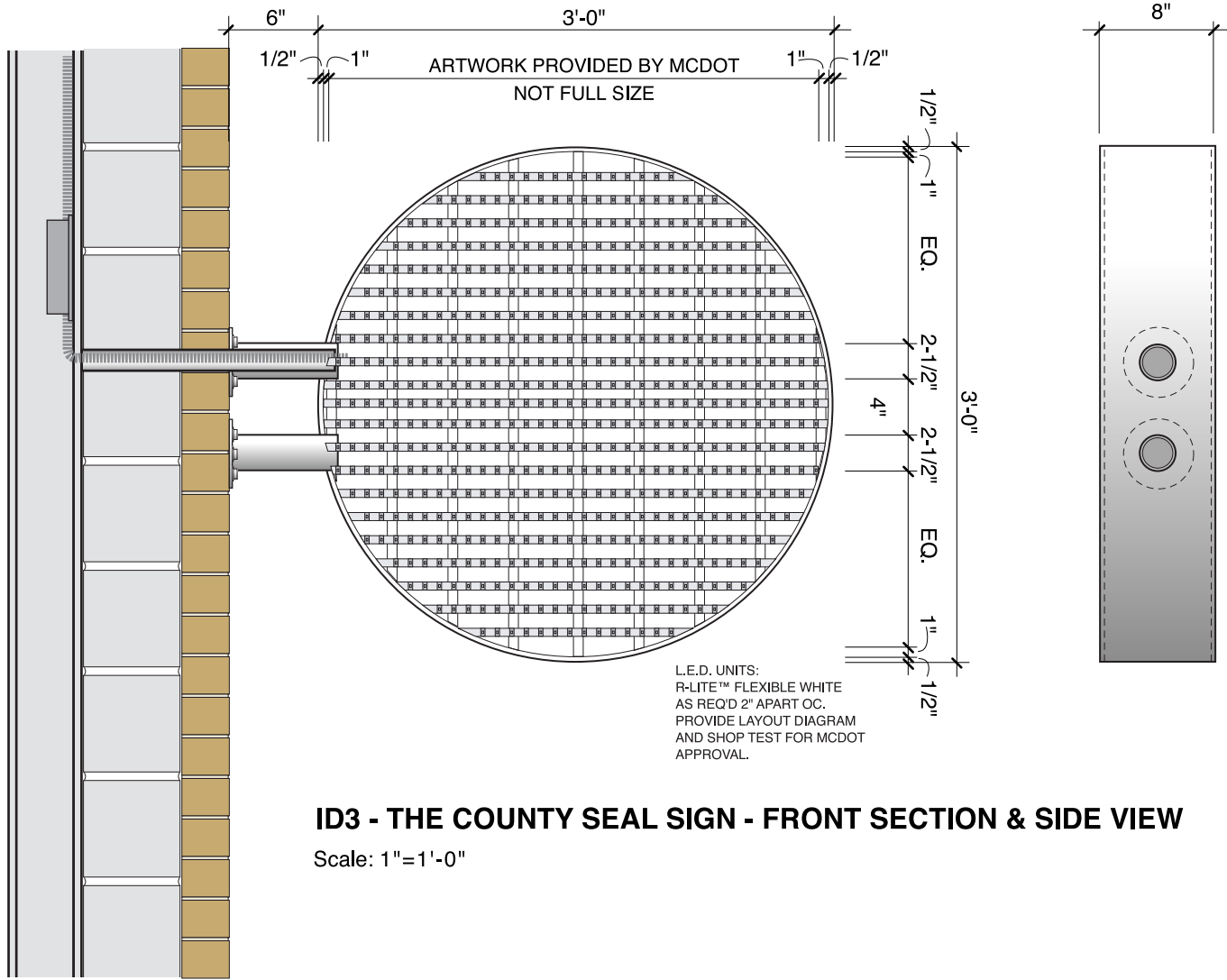

Projecting two-sided or single face wall mounted flat, internally illuminated County Seal cabinet signs to be installed on walls above garage entries with bottom of cabinet at minimum 10'-0" above finished grade. Verify exact locations with MCDOT.

Internally illuminated sign cabinets to be lit by L.E.D. units: Hyperion R-lite™ patented flexible LED illumination system, or equal. Input: 7.6 volts ac, power consumption 9w per linear foot, modules spaced 2" apart on center.

Illuminated signs to operate on/off by concealed photocell at top. Cabinets to be shop tested. Confirm dimensions & 'as built' conditions at job site and design cabinet to be positioned on and fit facade proportionally, prior to submission of shop drawings.

All fasteners to be non-corrosive. submit samples of all materials & finishes (8.5x11) to MCDOT for approval prior to fabrication.

Sign Contractor to provide shop drawings with engineer's seal for confirmation of elec. connection and structural mounting integrity. Sign Contractor to obtain electrical permits for all illuminated signs, and transmit to MCDOT prior to installation. provide wiring diagram for placement of LED units to ensure even illumination and conduct shop test for MCDOT approval prior to installation.





#### ID4 - THE COUNTY PYLON SIGN - FRONT & SIDE VIEWS

Scale: 3/4"=1'-0"

Freestanding double or single sided internally illuminated project identity pylon signs to be fabricated from aluminum with welded framework concealed by .125 panel skin. Face panels to be 3/8" thick clear polycarbonate with seal art on translucent digital print on outer surface, backed up by translucent white as shown. Digital art to be provided by MCDOT. Digital prints to be protected by outer layer of 3M™ 1160 film with UV inhibitor. Face panel polycarbonate to receive cladding on back of 3m diffuser film 3635-70 for 60% light transmission. Sign contractor to provide section through face panel on shop drawings for confirmation of applications and mounting.

Lettering is applied "frisket" technique, by application of film, spray prime & paint, and removal of film to expose polycarbonate. Typeface for this sign is garamond to coordinate with County image.

Upper cabinet background & sides painted blue Pantone 300C. Lower cabinet background & sides and skirt painted white to match 3M™ "Eggshell" color. 1" square reveal painted metallic gold like 3M™ Gold Metallic.

Aluminum skirt at bottom to have exposed fasteners at one end (closest to garage) for access during installation & maintenance. Code required on/off switch to be on located on that panel. Photocell concealed in top panel.



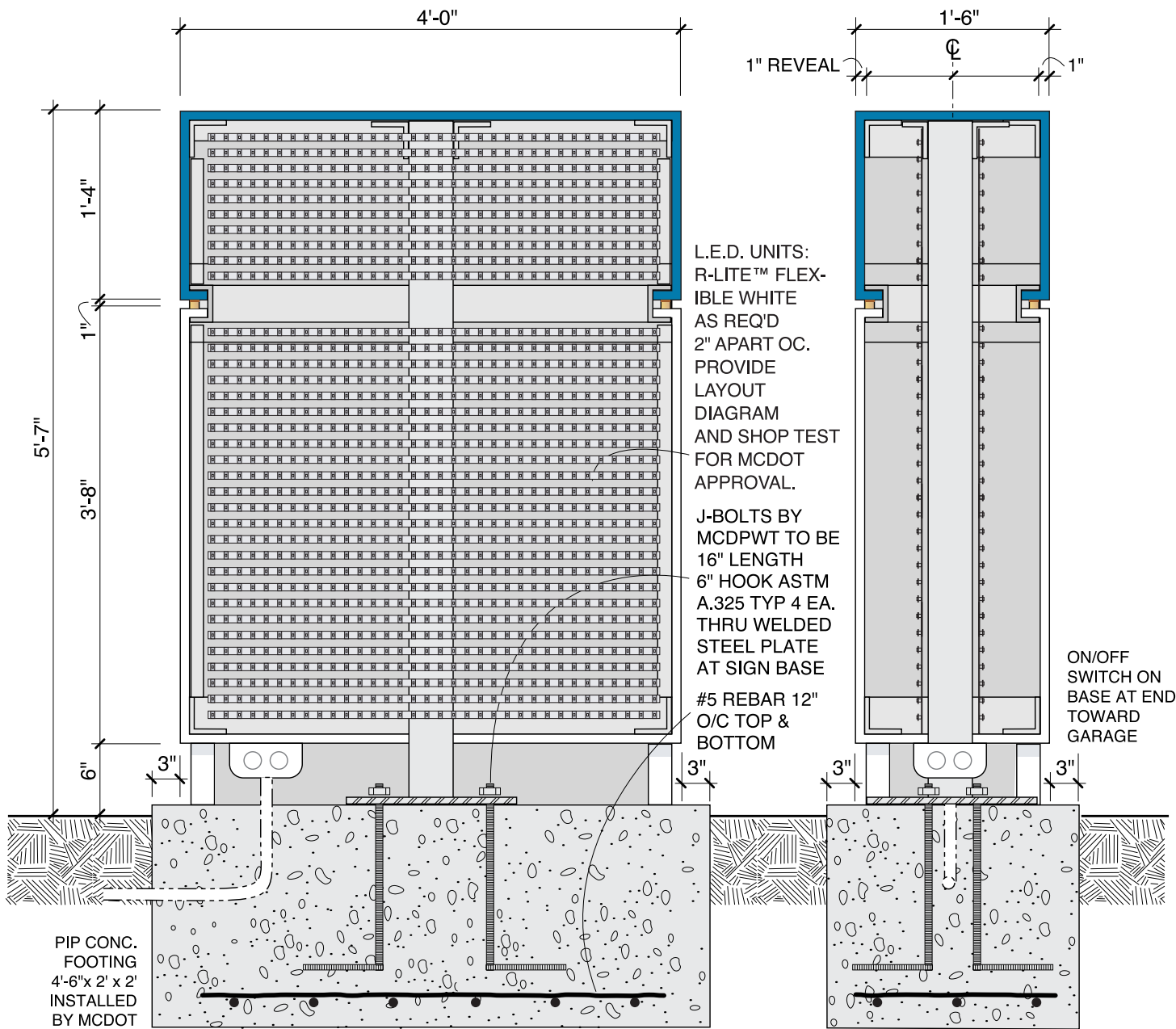

### ID4 - THE COUNTY PYLON SIGN - FRONT & SIDE VIEWS

Scale: 3/4"=1'-0"

Freestanding double or single sided internally illuminated project identity pylon signs to be fabricated from aluminum with welded framework concealed by .125 panel skin. Internally illuminated sign cabinets to be lit by L.E.D. units: Hyperion R-lite™ patented flexible LED illumination system, or equal. Input: 7.6 volts ac, power consumption 9w per linear foot, modules spaced 2" apart on center.

Illuminated signs to operate on/off by concealed photocell at top. Cabinets to be shop tested for MCDOT approval in shop.

All fasteners to be non-corrosive. Submit samples of all materials & finishes (8.5x11) to MCDOT for approval prior to fabrication.

Sign Contractor to provide shop drawings with engineer's seal for confirmation of elec. connection and structural & anchoring / mounting integrity. Sign Contractor to obtain electrical permits for all illuminated signs, and transmit to MCDOT prior to installation. provide wiring diagram for placement of LED units to ensure even illumination and conduct shop test for MCDOT approval prior to installation.

Provide cast-in-place concrete base and 1/2" dia. j-bolt stubbed up to meet electrical service following template provided during shop drawing submission. Coordinate foundations with civil and landscape plans and coordinate power with County Electrical Engineer.



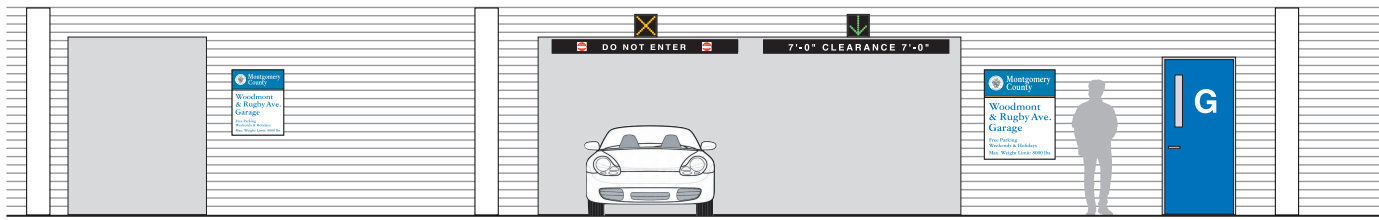

**ID5 - COUNTY WALL MOUNTED PANEL - POSSIBLE LOCATIONS - NTS**

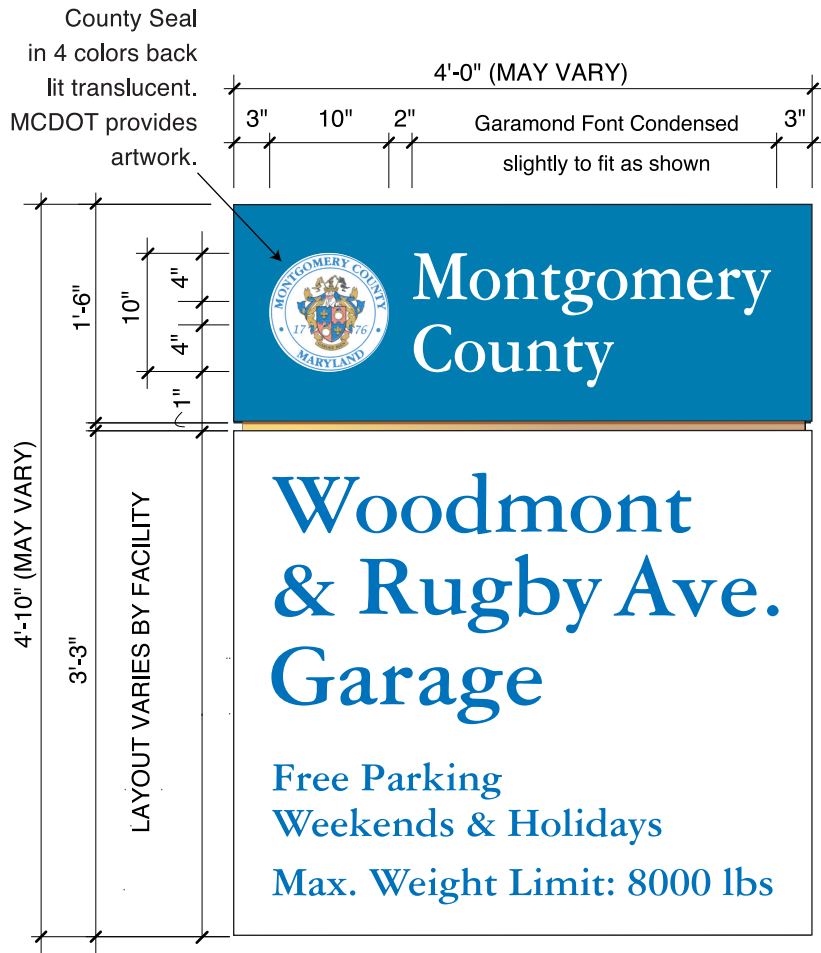

**ID5 - COUNTY WALL MOUNTED PANEL FRONT & SIDE VIEWS**

Scale: 3/4"=1'-0"

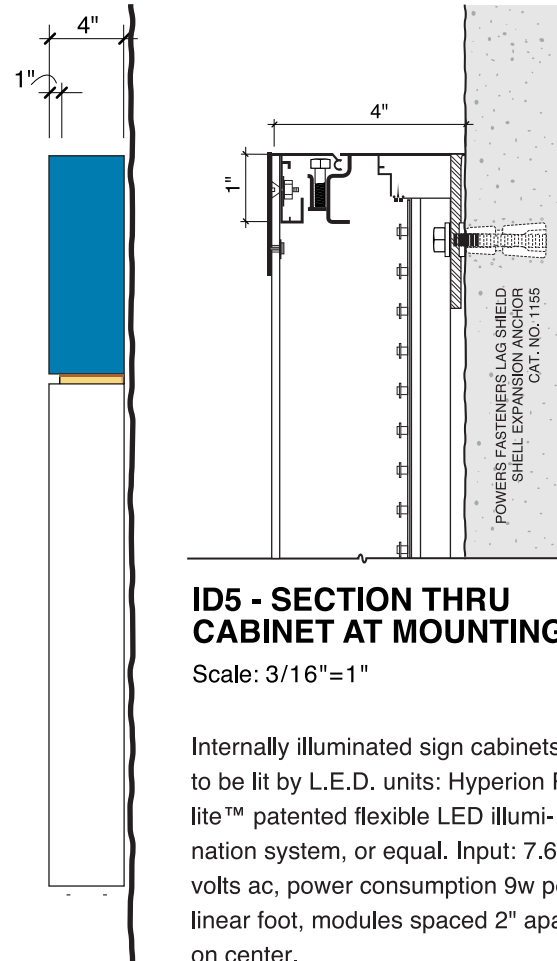

**ID5 - SECTION THRU CABINET AT MOUNTING**

Scale: 3/16"=1"

Internally illuminated sign cabinets to be lit by L.E.D. units: Hyperion R-lite™ patented flexible LED illumination system, or equal. Input: 7.6 volts ac, power consumption 9w per linear foot, modules spaced 2" apart on center.

Signs may also be non-illuminated with reflective film lettering and art.

Wall mounted internally illuminated project identity sign cabinets to be fabricated from aluminum with welded framework concealed by .125 panel skin. Face panels to be 3/8" thick clear polycarbonate with seal art on translucent digital print on outer surface, backed up by translucent white as shown. Digital art to be provided by MCDOT. Digital prints to be protected by outer layer of 3M™ 1160 film with UV inhibitor. Face panel polycarbonate to receive cladding on back of 3m diffuser film 3635-70 for 60% light transmission. Sign contractor to provide section through face panel on shop drawings for confirmation of applications and mounting.

Lettering is applied "frisket" technique, by application of film, spray prime & paint, and removal of film to expose polycarbonate. Typeface for this sign is garamond to coordinate with County image.

Upper cabinet background & sides painted blue Pantone 300C. Lower cabinet background & sides and skirt painted white to match 3M™ "Eggshell" color or Matthews Paint "Winter Sky". 1" square reveal painted metallic gold like 3M™ Gold Metallic.

Code required on/off switch to be on located on top panel. Photocell concealed in top panel. Face mounted with concealed fasteners top & bottom to be removable for maintenance. Refer to ID4 details & MCDOT Sign Specifications for lighting & power connection notes.



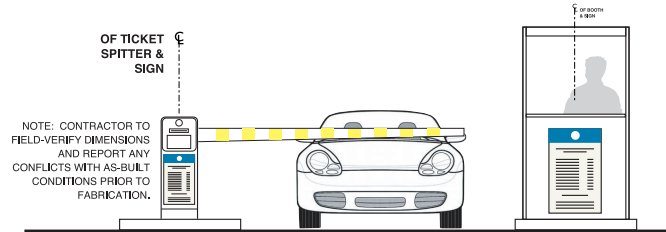

**ID6 - DETAIL AT MOUNTING TYPICAL**

Not to Scale

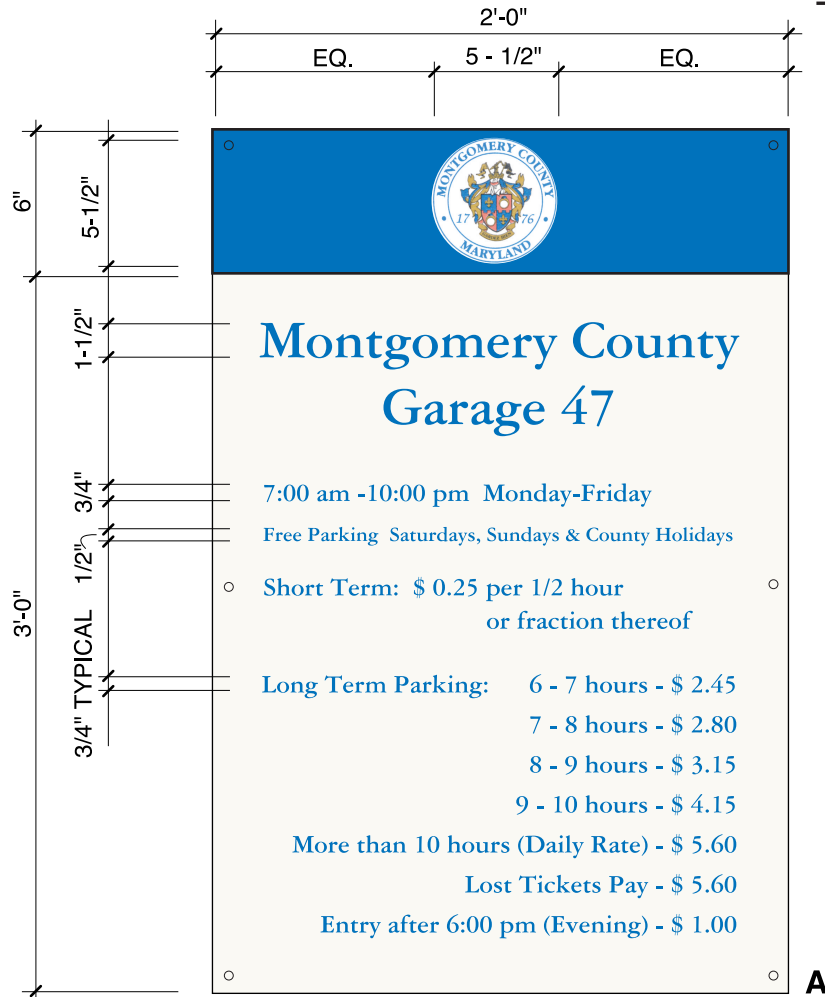

**ID6 - DISPLAY OF RATES AT ENTRIES  
DETAIL LAYOUTS AT SIZES "A" & "B"**

Scale: 1-1/2"=1'-0"

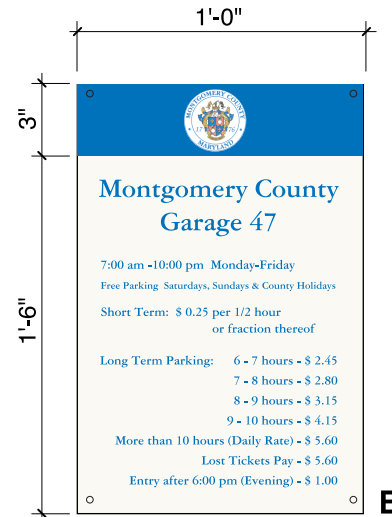

Wall / surface mounted RATES sign of .125" thick aluminum precision cut with edges and corners filed & eased to remove sharpness. All surfaces primed & painted with acrylic polyurethane eggshell finish.

Copy background painted white to match 3M™ Eggshell or Matthews Paint "Winter Sky". Top band and lettering on lower field are silkscreened Blue 300C. 5" Co. seal to be silkscreened in 4-colors following artwork application standard. MCDOT to provide specifications.

Typeface: Garamond Bold. Provide layout proof for MCDOT approval prior to application of copy.

Panels mount to "pull-thru" booths with tamper-proof sheet metal screws in position as MCDOT directs. Signs may also mount via pop rivets as shown. rivets to be painted to match backgrounds.

Large size A generally used at vehicular entrances. Smaller size B mounted at Pedestrian entries to garage. Exact sign locations to be verified with MCDOT staff prior to anchoring & installation.



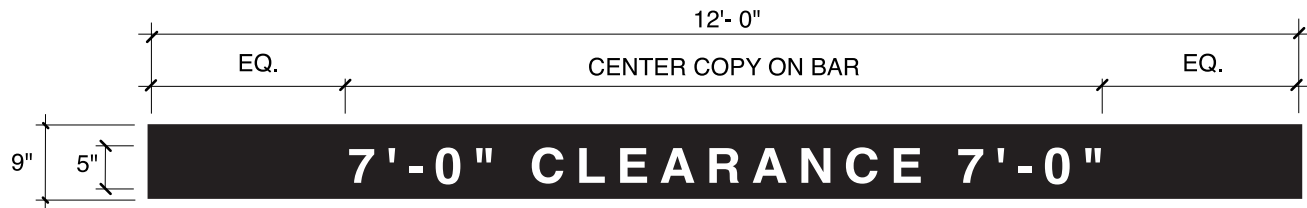

**NOTE: VERIFY FINAL CLEARANCE WITH COUNTY PRIOR TO LAYOUT**

### CE1 CLEARANCE BAR WITH DIMENSIONS - LAYOUT STANDARD

Scale: 1/2"=1'-0"

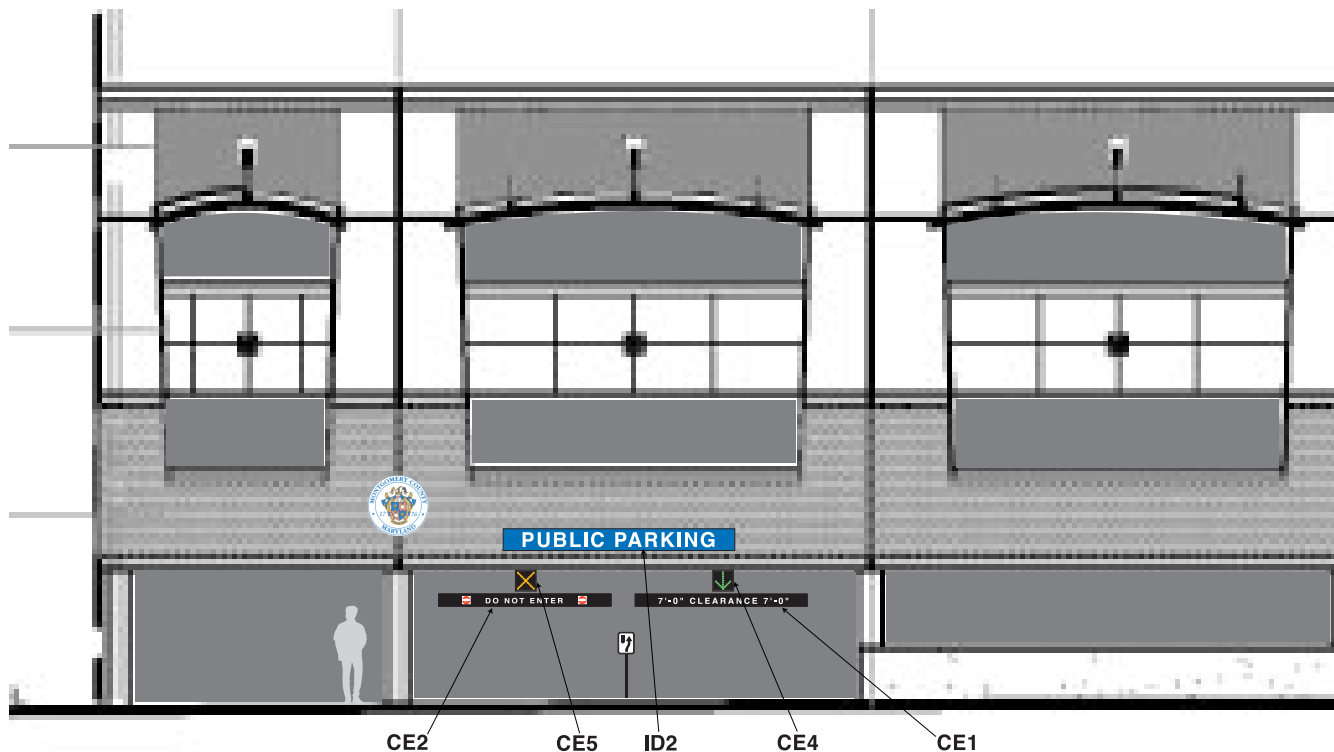

### CE1 CLEARANCE BAR WITH RELATED ELEMENTS

Not to Scale

9" diameter Clearance Bars also known as "headache" bars and "head knockers" to be assembled of 0.5" thk. black HDPE with mechanically fastened (screwed on) & sealed black end caps to prevent bird-nesting. End caps to be fastened with counter-sunk screws to be removable. Provide minimum (2) -1/2" dia. weep holes in bottom of pipe, 12" in from each end, for ventilation and draining.

Bars to be suspended from new steel chain and hardware as required by conditions at sign location and as indicated on shop drawings with Engineer's Seal, submitted to MCDOT for approval prior to fabrication.

Lettering to be Helvetica Bold white reflective exterior grade film centered on black pipe as shown. Bars to be centered above drive lanes. Verify as built garage dimensions in field. Length of bars may vary to fit conditions at jobsite.

Note: 5" film lettering to be positioned for readability as shown on diagrams page 30. Refer to mounting diagrams on page 30 for sections at some conditions. Actual mounting conditions for each facility differ and must be documented on engineered drawings to satisfy MCDOT requirements.



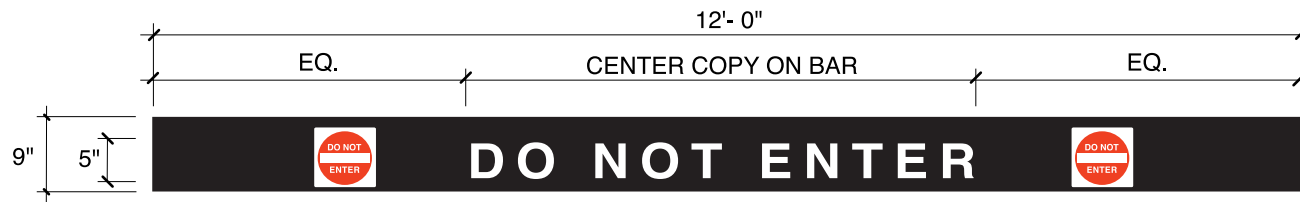

### CE2 DO NOT ENTER BAR - LAYOUT STANDARD

Scale: 1/2"=1'-0"

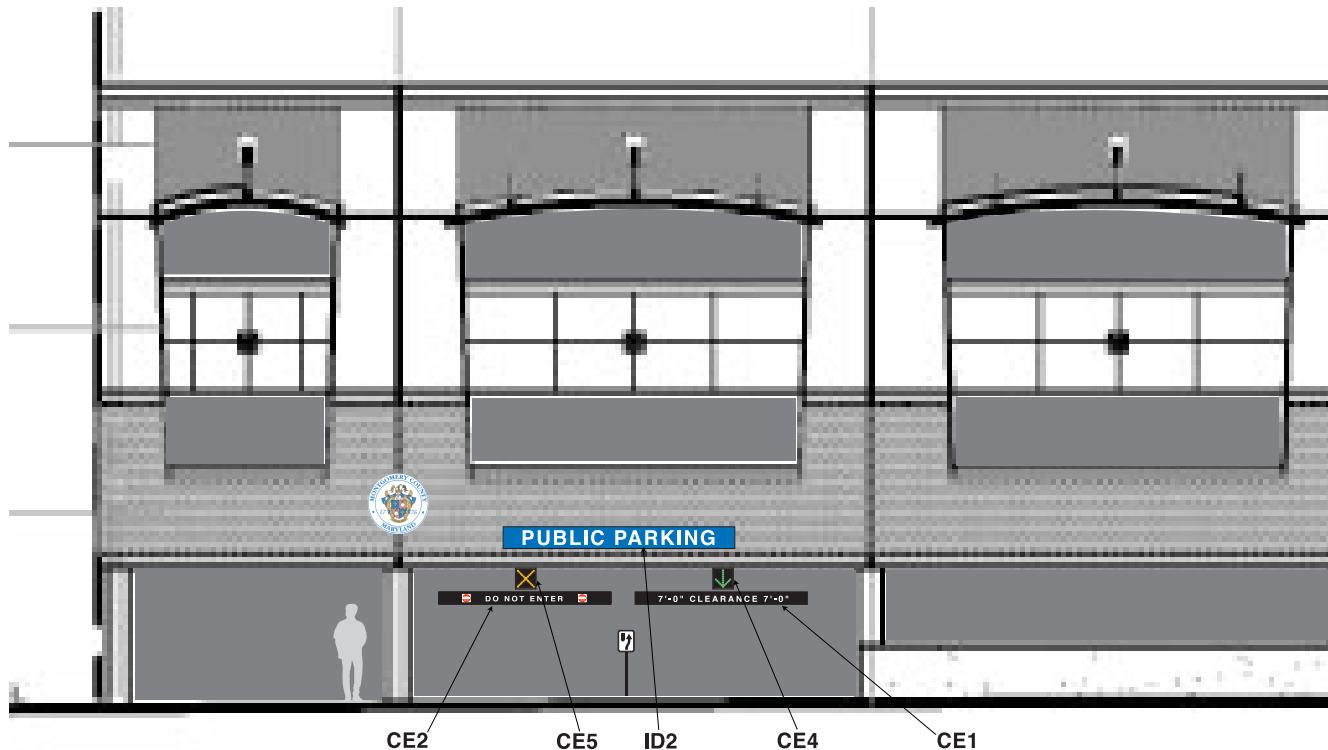

### CE2 DO NOT ENTER BAR WITH RELATED ELEMENTS

Not to Scale

9" diameter DO NOT ENTER Bars also known as "headache" bars and "head knockers" to be assembled of 0.5" thk. black HDPE with mechanically fastened (screwed on) & sealed black end caps to prevent bird-nesting. End caps to be fastened with counter-sunk screws to be removable. Provide minimum (2) -1/2" dia. weep holes in bottom of pipe, 12" in from each end, for ventilation and draining.

Bars to be suspended from new steel chain and hardware as required by conditions at sign location and as indicated on shop drawings with Engineer's Seal, submitted to MCDOT for approval prior to fabrication.

Lettering to be Helvetica Bold white reflective exterior grade film centered on black pipe as shown. Bars to be centered above drive lanes. Symbols to be White and Red reflective film as specified in County Sign Specifications. Same bar may have layout CE3 on backside. For 2-sided signs indicate "A" and "B" on sign location plans and sign message schedule.

Note: 5" film lettering to be positioned for readability as shown on diagrams page 30. Refer to mounting diagrams on page 30 for sections at some conditions. Actual mounting conditions for each facility differ and must be documented on engineered drawings to satisfy MCDOT requirements.



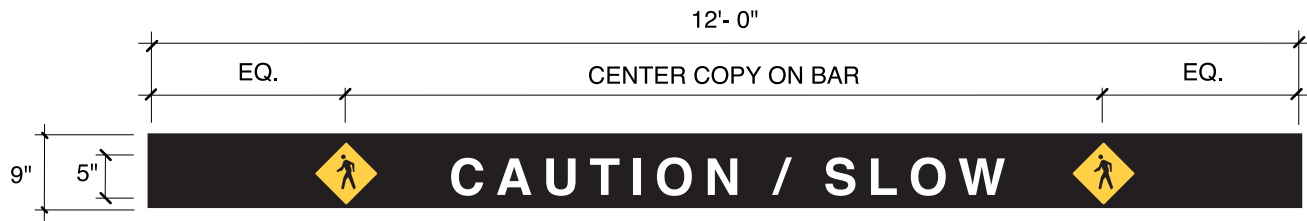

**CE4 CAUTION / SLOW BAR LAYOUT STANDARD**

Scale: 1/2"=1'-0"

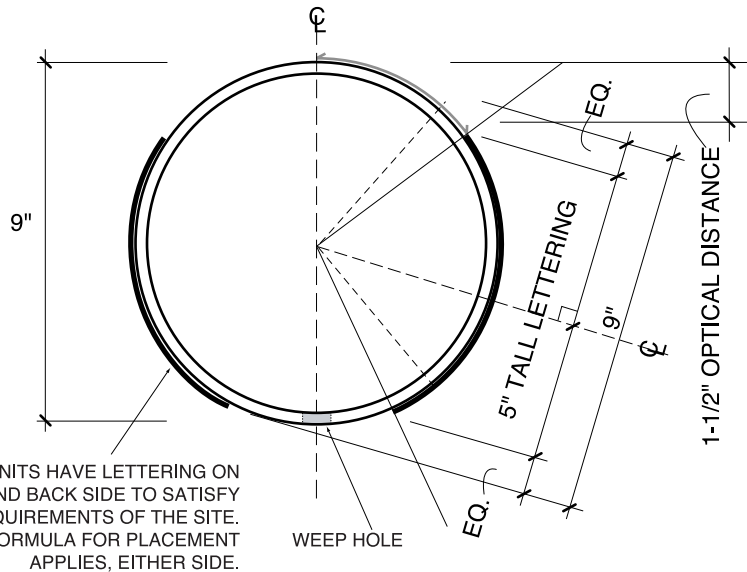

**CE1, 2, 3 LETTERING APPLICATION**

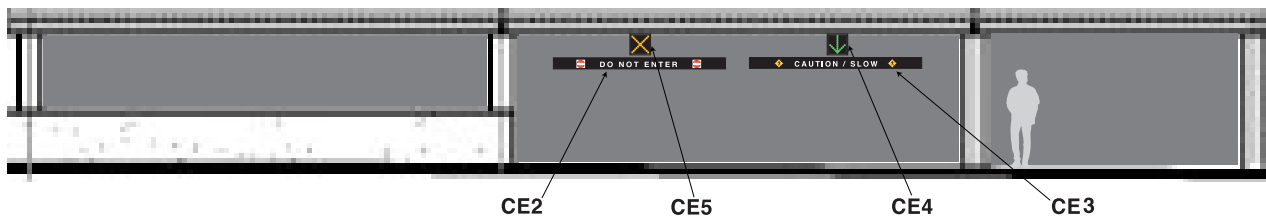

**CE3 CAUTION / SLOW BAR WITH RELATED ELEMENTS**

Not to Scale

CAUTION / SLOW layout generally applied to backside of CE1 or CE2 and may be indicated in sign message schedules as layout CE3.

Bars to be suspended from new steel chain and hardware as required by conditions at sign location and as indicated on shop drawings with Engineer's Seal, submitted to MCDOT for approval prior to fabrication.

Lettering to be Helvetica Bold white reflective exterior grade film centered on black pipe as shown. Bars to be centered above drive lanes. Symbols to be Yellow and Black reflective film as specified in County Sign Specifications. Same bar may have layout CE1 or CE2 on backside. For 2-sided signs indicate "A" and "B" on sign location plans and sign message schedule.

Note: 5" film lettering to be positioned for readability as shown on diagram. Optional source for HDPE pipe is LAIRD PLASTICS 800-873-8405.

Refer to page 31 for other section detail and notes regarding fabrication and installation of Clearance Bars.



Mounting plate size determined by sign fabricator's structural engineer to fit condition at garage entry/exit and to satisfy weight of unit and impact requirements, taking stationary and moving loads into account. All attachments to include neoprene pad between metal plates and garage surfaces.

Outside (front) of parking garage facility conditions / drawings to be verified and employed.

Note: confirm all architectural details on drawings and in the field with MCDOT Representative and provide photo documentation in sign system package.

Note: Units may have lettering on front and / or back side as required by conditions of traffic pattern at job site. Refer to pages 28-30 for layouts and guide.

Confirm orientation of all units with MCDOT prior to submission of shop drawings and programming proofs.

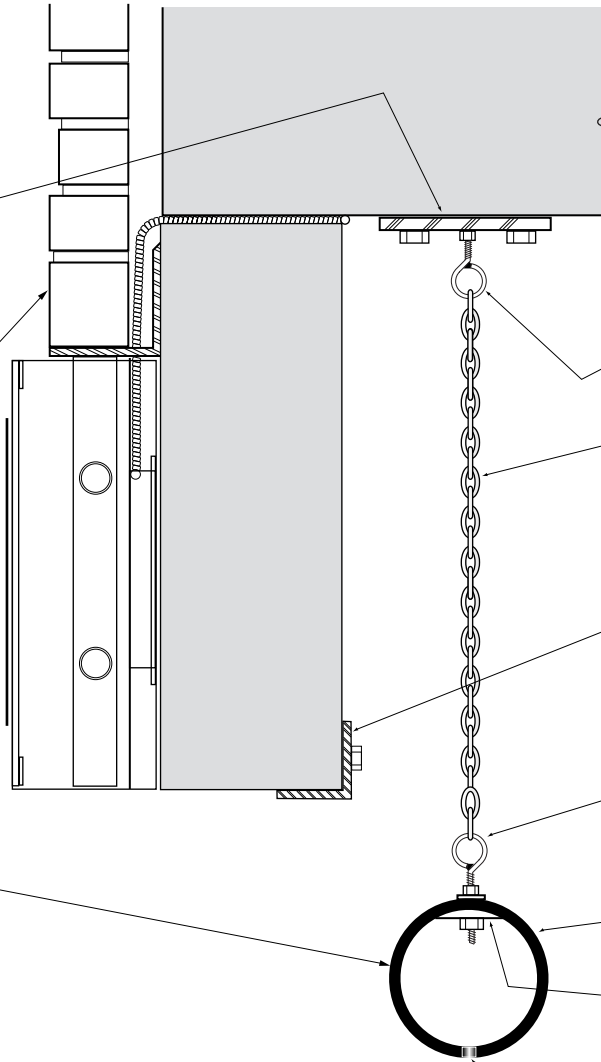

Clearance bar assemblies to employ hanger chains with spacing 2'-6" o.c. max. (4) min. per bar.

At top plates and HDPE pipe, attach galvanized 3/8"x 3"x1" i.d. eyebolt w/ double nut lock & flat washers.

Minimum 3/16" x .95" link case hardened galvanized steel chains to be employed.

Galvanized steel angles mount to facade: 3"x3-1/4"x6"x.125" thick to coincide with chain locations to protect garage wall from contact with chains. angle is fastened with 4 HILTI™ fasteners .

Galvanized steel eye-hooks mounted into HILTI™ #5520410 kwik tog II eye-hooks to be welded shut at installation after MCDOT approval of installation.

9" dia. 1/2" thick HDPE pipe w/ sealed flush end caps.

At chain attachment to pvc pipe, mounting plate fastened with HILTI™ #304ss14-134 "kwikbolt" w/ s.s. nut & 1" s.s. washer.

Provide minimum (2) -1/2" dia. weep holes in bottom of pipe, 12" in from each end, for ventilation and draining.





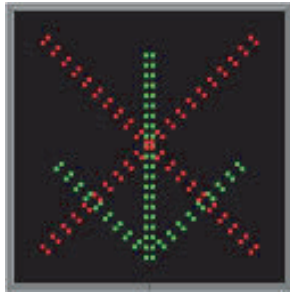
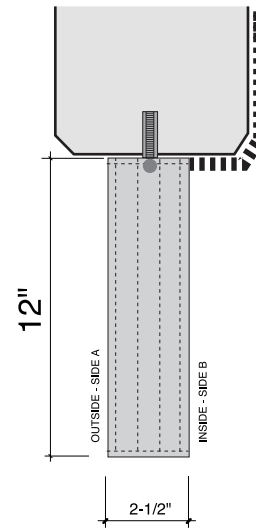
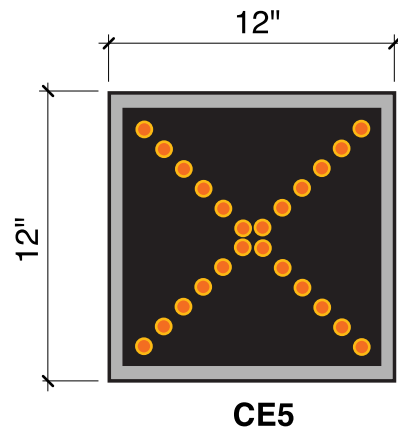
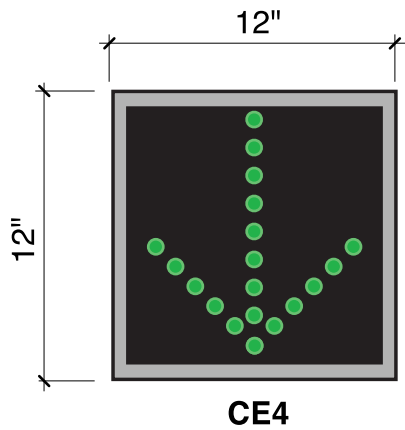

Electronic signs for lane directional designation to be mounted at garage entry / exits. Mounting conditions vary. Units may be ceiling or wall mounted.

The County standard for designation of lane direction is a unit manufactured by HOWARD INDUSTRIES 6400 Howard Drive, Fairview, PA 16415-2912 T 800 / 458-0591. TCL1212RG-175X / down arrow can be seen at [www.howardindustries.com](http://www.howardindustries.com)

LED traffic controller units provide super-bright, wide-angle, and energy efficient illumination. Units to be mounted to concrete or steel beams at entry exit lanes. House units in .125 custom fabricated steel box primed & painted black, eggshell finish.

Illuminated box signs to be positioned on center of traffic lane at exact locations as MCDOT directs. Sign contractor to provide shop drawings with mounting sections, connections and engineer's seal for MCDOT approval prior to fabrication and installation.

Power to sign locations provided by electrical contract and coordinated on sign contractor's shop drawing submissions. Sign contractor to obtain electrical permits for signs and deliver to MCDOT at installation.

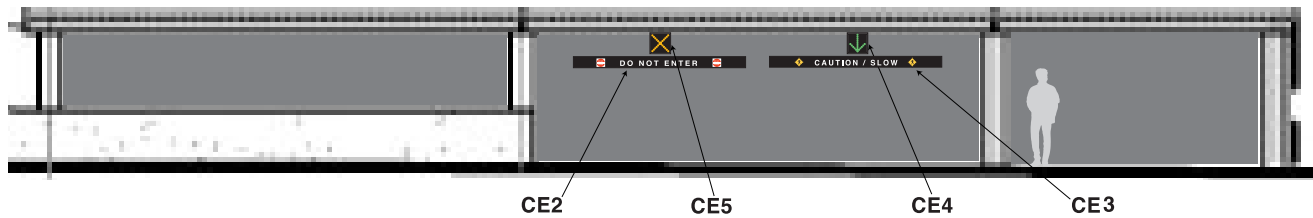

**CE4 - GREEN ARROW AND CE5 - RED "X" IN ELEVATION WITH RELATED ELEMENTS**

Not to Scale



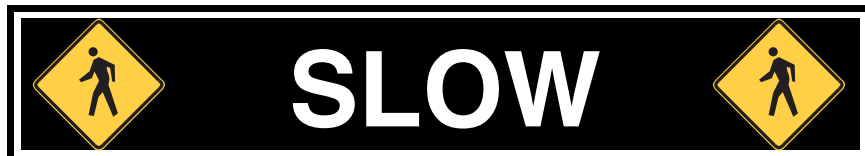
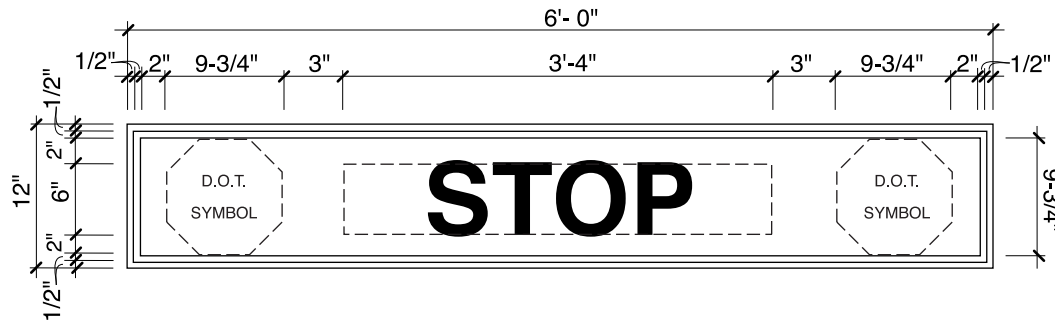

## DR6 - DIRECTIONAL SIGNS 6 FOOT LENGTH

Scale: 3/4" = 1'-0"

Directional signs (of all sizes) also known as overhead vehicular direction panels. 6 foot long panels are ONLY employed if the 8 foot long sign will not fit. Signs to be custom fabricated of .080 alum. with edges & corners filed & eased. No sharp edges or surfaces. All surfaces, front, back & sides to be primed & painted black, egg shell finish with acrylic polyurethane.

Note: Face panels mount to concrete beams and welded steel frames at double faced conditions. all fasteners to be primed & "painted out" to match black background.

All lettering & arrows to be white reflective film per MCDOT specifications. Typeface: Helvetica Bold upper/lower case or all capitol letters as shown. Generally lettering is 6" tall. Lettering may be reduced to fit (like Right Turn Only). Lettering may not be condensed to fit. Do not squeeze lettering.

Note: DOT symbols , when employed on overhead signs, to be reflective vinyl, cut by computer in sizes as shown. Background of 'Do Not Enter' to be red 280-72. Background of HC symbol to be light blue reflective vinyl 280-76. Ped Xing symbol field yellow reflective vinyl 280-71 with black figure & border. Some borders to be white. No more than 2 layers of film should be used for symbols.

Submit layout proofs (may be small scale) to MCDOT for confirmation of font, arrow art and dimensions, prior to affecting materials. Note: Copies of sign manual pages do not constitute proof and are not acceptable for submission or approval. Layouts to be provided by sign manufacturer.

Refer to pages following for other layout and size options and fabrication standard details and dimensions.



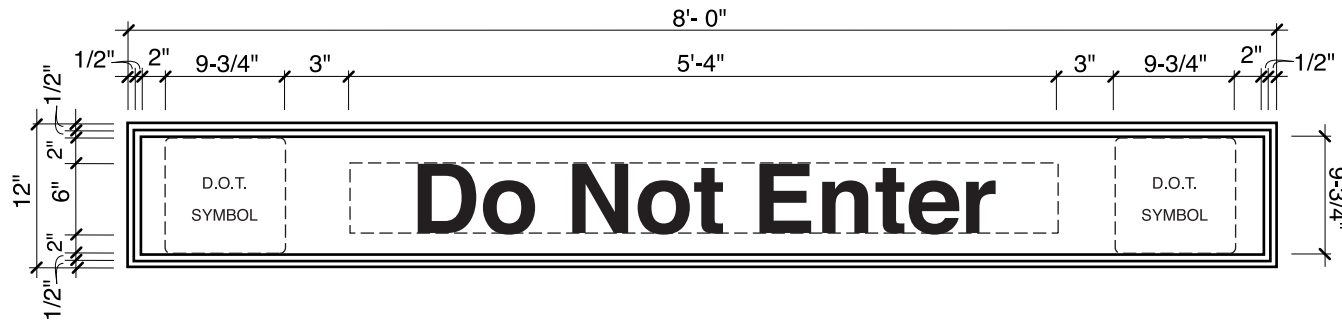

### DR8 - DIRECTIONAL SIGNS 8 FOOT LENGTH

Scale: 3/4" = 1'-0"

Directional signs (of all sizes) also known as overhead vehicular direction panels. 8 foot long panels are most common size. 10 and 12 foot panels may be employed for longer line conditions. Signs to be custom fabricated of .080 alum. with edges & corners filed & eased. No sharp edges or surfaces. All surfaces, front, back & sides to be primed & painted black, egg shell finish with acrylic polyurethane.

Note: Face panels mount to concrete beams and welded steel frames at double faced conditions. all fasteners to be primed & "painted out" to match black background.

All lettering & arrows to be white reflective film per MCDOT specifications. Typeface: Helvetica Bold upper/lower case or all capitol letters as shown. Generally lettering is 6" tall. Lettering may be reduced to fit (like Right Turn Only). Lettering may not be condensed to fit. Do not squeeze lettering.

Note: DOT symbols , when employed on overhead signs, to be reflective vinyl, cut by computer in sizes as shown. Background of 'Do Not Enter' to be red 280-72.

Background of HC symbol to be light blue reflective vinyl 280-76. Figures & borders to be white. no more than 2 layers of film should be used for symbols.

Submit layout proofs (may be small scale) to MCDOT for confirmation of font, arrow art and dimensions, prior to affecting materials.

Refer to pages following for other layout and size options and fabrication standard details and dimensions.



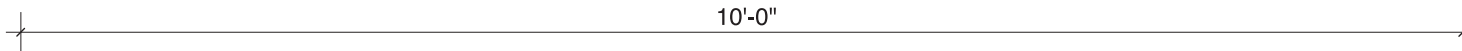
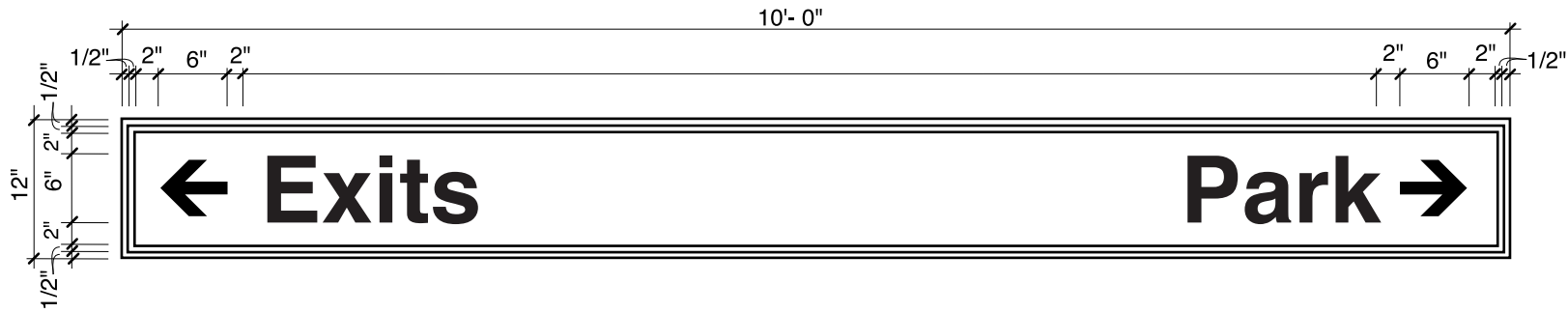

10 foot long directional sign panels are employed for longer line conditions.

Signs to be custom fabricated of .080 alum. with edges & corners filed & eased. No sharp edges or surfaces. All surfaces, front, back & sides to be primed & painted black, egg shell finish with acrylic polyurethane.



Note: Face panels mount to concrete beams and welded steel frames at double faced conditions. all fasteners to be primed & "painted out" to match black background.



All lettering & arrows to be white reflective film per MCDOT specifications. Typeface: Helvetica Bold upper/lower case or all capitol letters as shown. Generally lettering is 6" tall. Lettering may be reduced to fit (like Right Turn Only). Lettering may not be condensed to fit. Do not squeeze lettering.

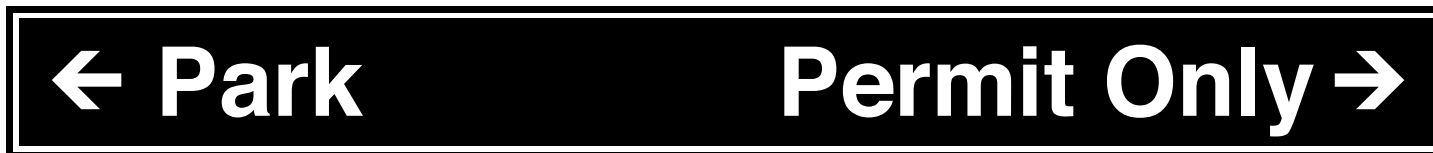

Submit layout proofs (may be small scale) to MCDOT for confirmation of font, arrow art and dimensions, prior to affecting materials.

### DR10 - DIRECTIONAL SIGNS 10 FOOT LENGTH

Scale: 3/4" = 1'-0"

Refer to pages following for other layout and size options and fabrication standard details and dimensions.



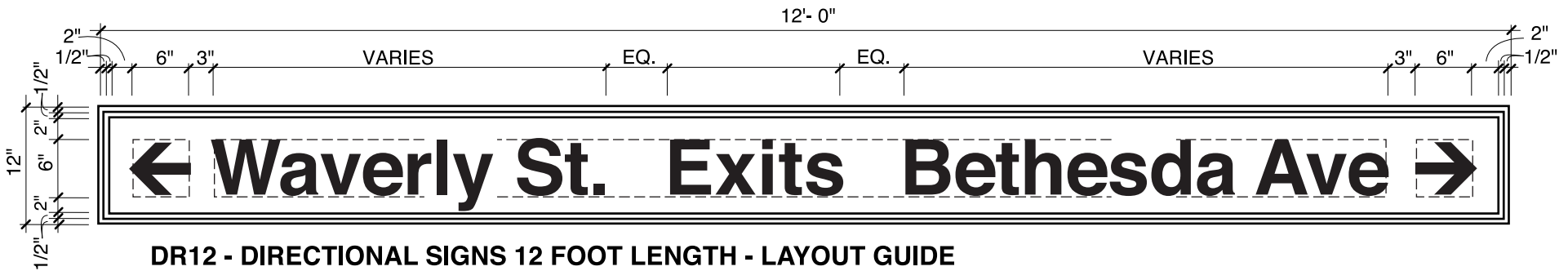

**DR12 - DIRECTIONAL SIGNS 12 FOOT LENGTH - LAYOUT GUIDE**

Scale: 3/4" = 1'-0"

12 foot long directional sign panels are employed for longer line conditions.

Signs to be custom fabricated of .080 alum. with edges & corners filed & eased. No sharp edges or surfaces. All surfaces, front, back & sides to be primed & painted black, egg shell finish with acrylic polyurethane.

All lettering & arrows to be white reflective film per MCDOT specifications. Typeface: Helvetica Bold upper/lower case or all capitol letters as shown.

"Welcome to" Layout with 8" County Seal art at left, to have 4-3/4" tall lettering. Most other signs to employ 6" lettering as shown.

Generally lettering is 6" tall. Lettering may be reduced to fit. Lettering may not be condensed to fit. Do not squeeze lettering.

Note: Face panels mount to concrete beams and welded steel frames at double faced conditions. all fasteners to be primed & "painted out" to match black background.

Refer to pages following for other layout and size options and fabrication standard details and dimensions.



**DR12 - DIRECTIONAL SIGNS 12 FOOT LENGTH**

Scale: 1/2" = 1'-0"

LENGTH MAY VARY TO FIT LOBBY CONDITIONS



**DRx - DIRECTIONAL SIGN SIZE USED FOR WAYFINDING**

Scale: 1/2" = 1'-0"



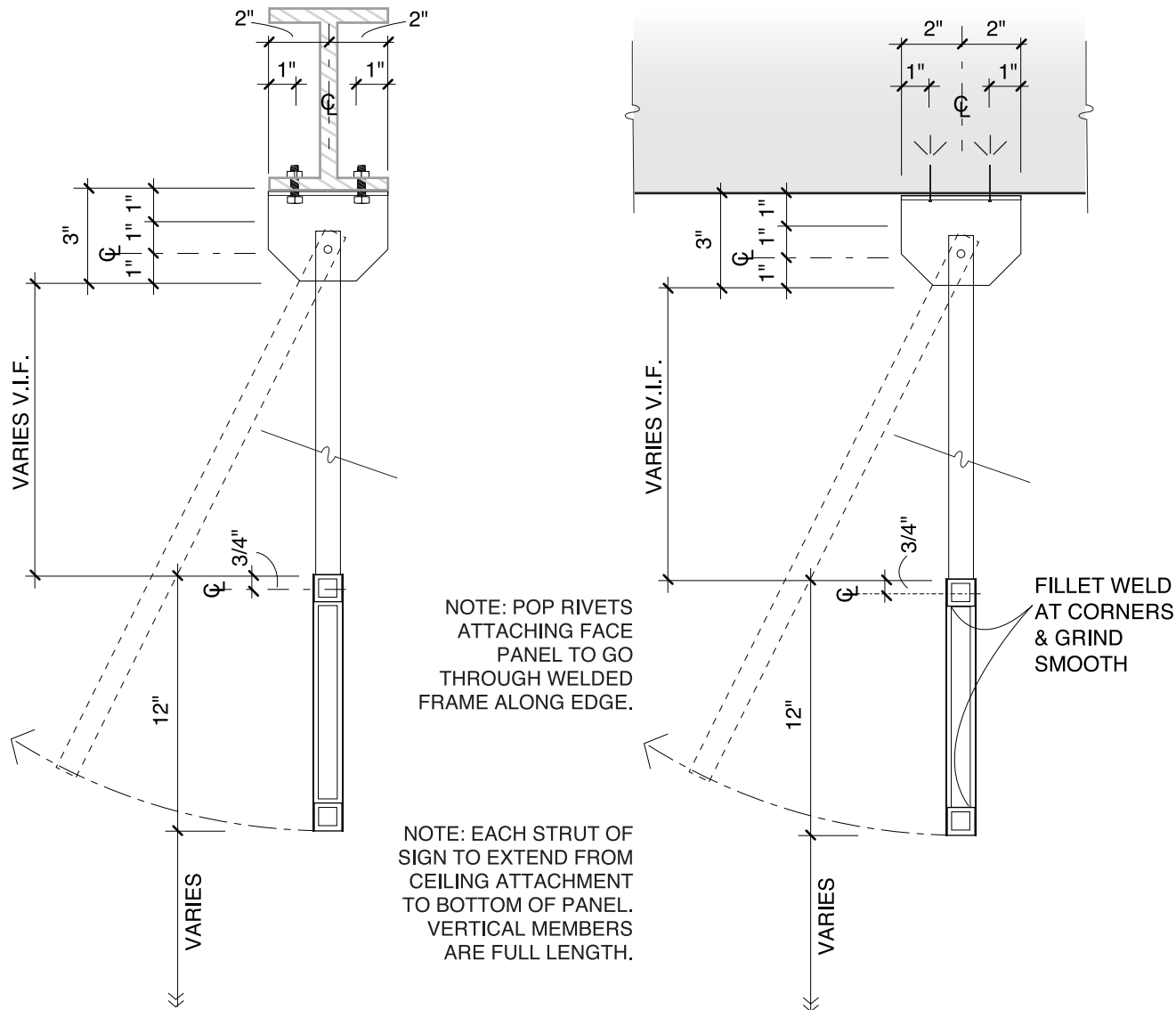

## DR - DIRECTIONAL SIGNS - TYPICAL FABRICATION DETAILS

Scale: 1-1/2" = 1'-0"

All suspended directional signs (also known as "hangers") to include 3/8" bolt & nut for pivot at peen thread connection - signs to swing when pressure is applied. 1/8"x 3"x 4" neoprene pad between bracket & surface of concrete to isolate dissimilar materials.

Overhead directional sign panels mount to concrete ceiling condition w/ anchor bolts through steel angle 3"x 4" x 1/4" w/ HILTI™ #304SS-14-134-1" max. embed. Peen threads as required.

1/8" thick x 1" square steel tube welded frame pivots on 3/8" nut & bolt w/ peen threads. Grind smooth at corners & welds of frame prior to mounting of sign face panels. Frame connections to be fillet welds ground smooth prior to attachment of face panels.

Bottom edge of sign face panel to hang level above finished floor. Length of legs to be cut in field to accommodate angled ceilings / ramps. Confirm all exact locations & frame lengths w/ MCDOT at job site prior to fabrication.

Note: Face panels to be fastened to welded framework with pop-rivets 24" on center, minimum. Pop rivets are primed & painted out to match black background.

Sign contractor to submit shop drawings with engineer's seal for confirmation of all details at mounting & attachment. Drawings to include product names & numbers & all sections/details necessary for the record. Obtain MCDOT approval of drawings prior to fabrication.



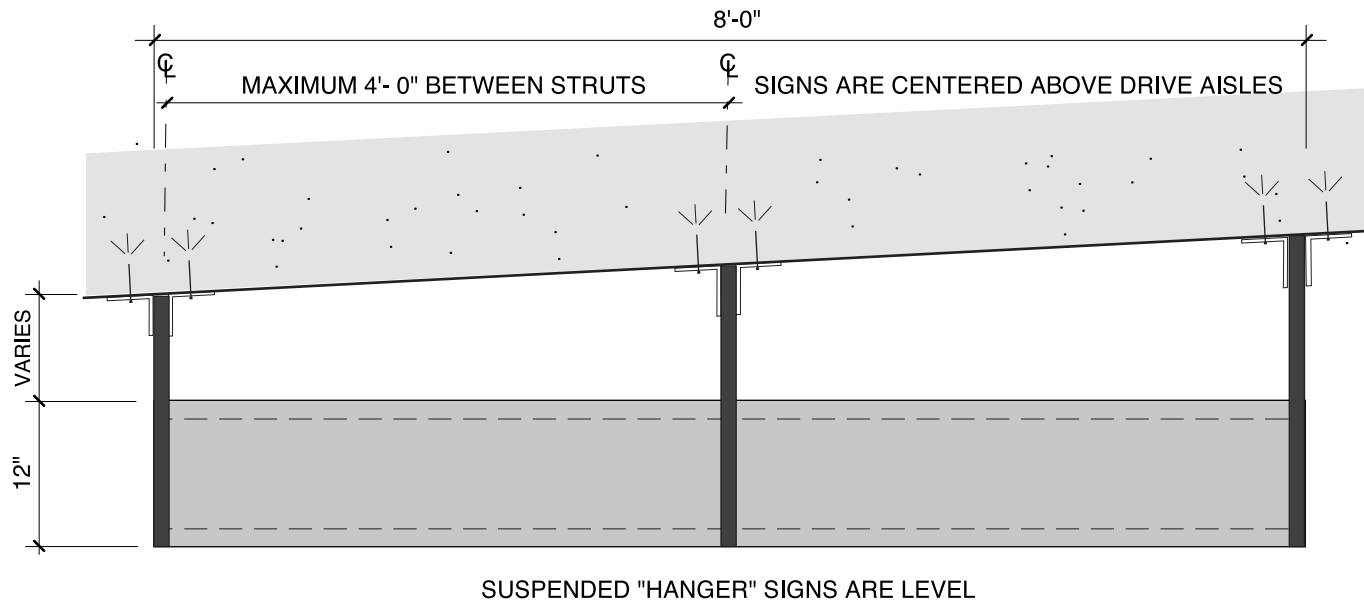

BEAM MOUNTED SIGNS ON 1" STRUTS TO LIMIT SURFACE CONTACT



STEEL BEAM MOUNTED SIGNS ALIGN WITH BOTTOM OF BEAM



CONCRETE BEAM MOUNTED SIGNS ALIGN WITH BOTTOM OF BEAM

## DR - DIRECTIONAL SIGNS - TYPICAL FABRICATION DETAILS

Not to Scale

Directional signs may be suspended, hanging from concrete ceilings, beams or steel beams, or they may be mounted directly to concrete or steel beams as required to satisfy visibility requirements.

When signs are mounted to concrete by 'hanger' assembly, 1/8"x 3"x 4" neoprene pad to be attached between mounting brackets and garage concrete ceiling. Note: All hanger hardware & backside surfaces painted matte black. all metal surfaces to be primed & painted black eggshell finish with acrylic polyurethane.

Struts (sign legs) to be field cut to length required to maintain level or alignment with bottom of nearest adjacent beam. Verify requirements with MCDOT at sign locations. Bottom of panels to typically hang 7'-6" above finished floor. Confirm all overhead sign locations with MCDOT at job site prior to installation.

Overhead sign panels, single or double faced suspended from extruded 1"x 1"x 1/8" steel tubes. pivot on 3/8" bolt through flange, which is bolted to concrete deck above as required. See page 37 for further details at hanger assembly.

Directional signs mounted to concrete beams or steel beams must align with the bottom edge of the beam. Signs are positioned on center above drive lanes and attach to beams with 1" square 12" long extruded aluminum tubes every 2'-0" on center, to minimize damage to beam surfaces.

Tubes are permanently adhered to back of sign and mount to beams with VHB tape. Dimensions of tubes may be increased for larger sign panels. Engineer to confirm attachment of all signs to prevent mounting failure and protect County from liability.

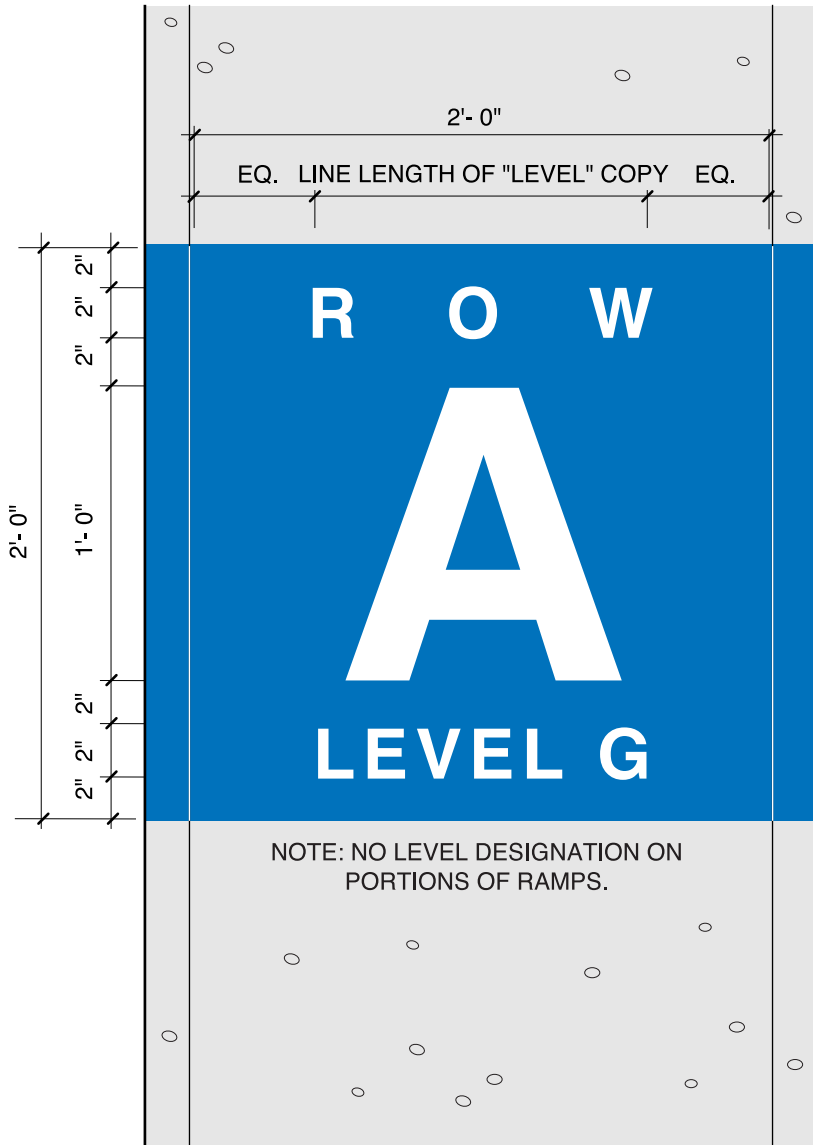

**PW1 - ROW/LEVEL DESIGNATION ON COLUMNS  
FRONT VIEW**

Scale: 1-1/2" = 1'-0"

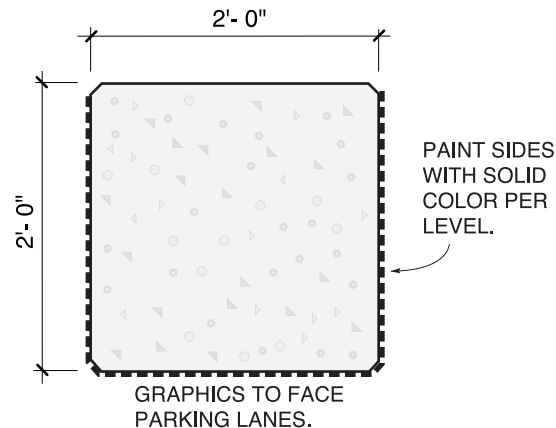
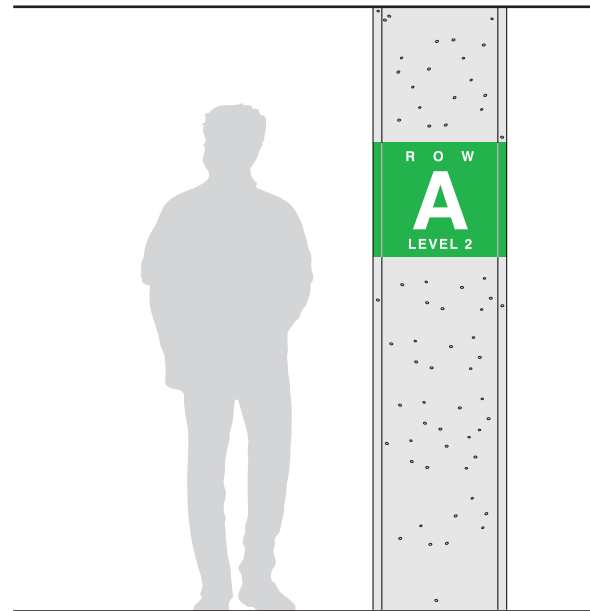

**PW1 - PLAN VIEW**

Scale: 3/4" = 1'-0"

Sign type PW1 requires coordination with painting and must be completed at proper temperatures. Refer to specifications for indications of coatings and use proper primer for surface of columns to be painted with bands. Color bands are painted prior to application of graphics.

Graphics to be hand-painted white from computer generated template artwork transferred to column. Row marking color bands are painted directly on primed concrete columns in colors to follow level designation standards.

In all cases paint face & sides of column in 24" wide band as shown. At end column conditions paint all 4 sides and apply graphics to opposite facing surfaces.

Position of band is consistent @ 5'-0" to center, above finished floor. bands on columns at ramps follow suit. do not paint four sides of column @ ramp condition.

Note: portions of ramps in garages of more than one level are not marked with level designation. coordinate exact locations with MCDOT.

Refer to color coding exhibit and sign specifications for indication of colors and coatings. Background of band represents color coding, all lettering and numerals to be painted white in Helvetica Bold font as shown.

All applications of painted graphics receive top coat of clear anti-graffiti protection per MCDOT Sign Specifications. All coatings to be applied during warmer months to insure proper adhesion.





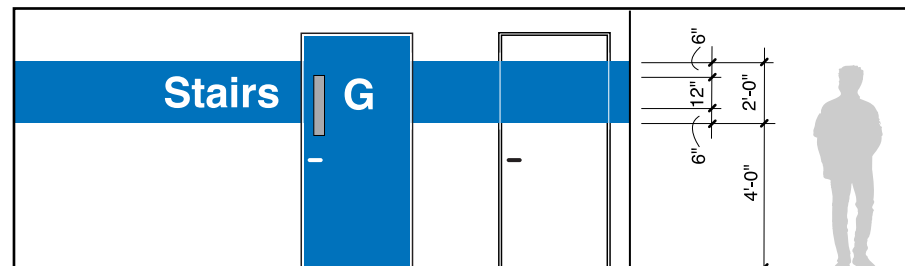
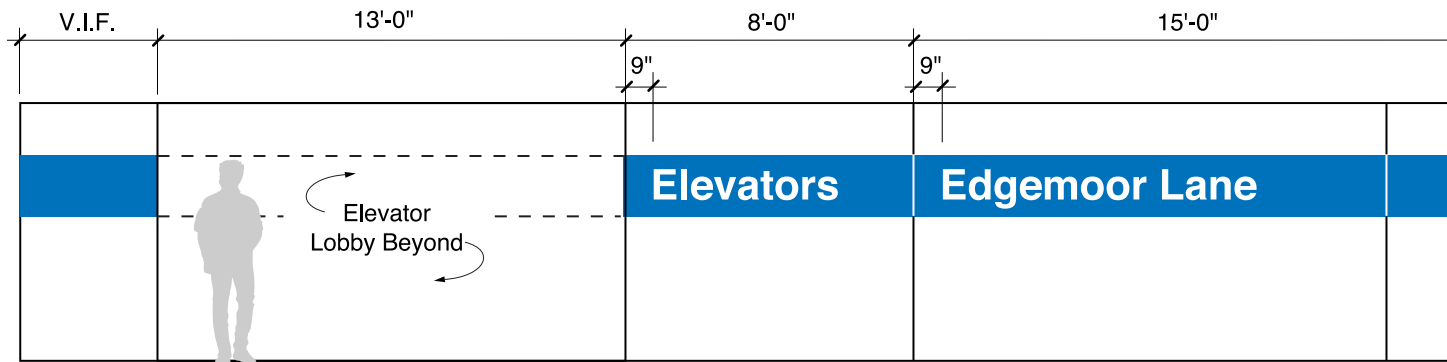
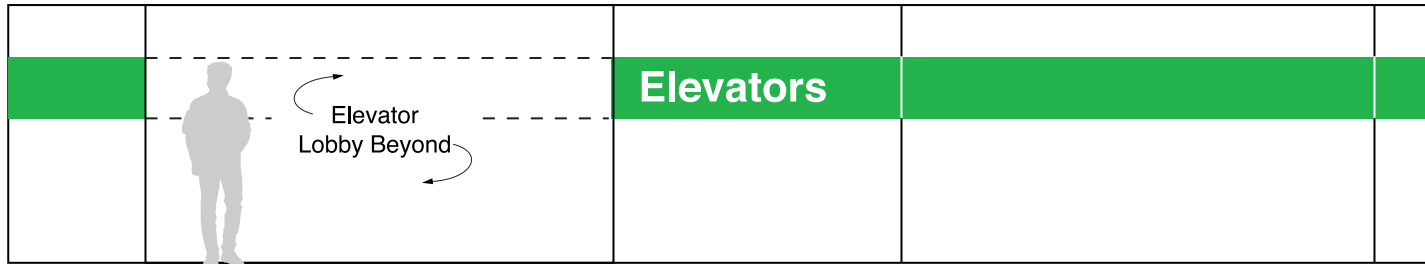
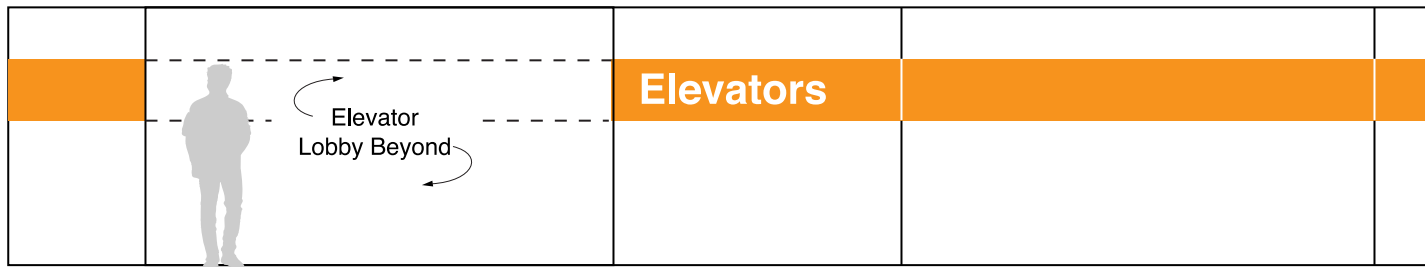

**PW2 - PAINTED BAND - ORIENTATION  
FRONT VIEW**

Not to Scale

Supergraphics are painted in colors to follow pattern of level designation color coding. Supergraphics should appear at locations where wayfinding landmarks are necessary to the facility function and operation.

PW2 is a painted band on the wall 2'-0" wide in length required to wrap the levator lobby or stair core to provide better visibility from a distance. 12" tall lettering is painted in white Helvetica Bold on colored band as shown.

Painted bands are indicated on plans in dotted line form to express extent of painting. Lettering is indicated in sign message schedule and on plan with Helvetica Bold.

Street names are used to orient customers to elevator and stair cores near desired exits. Street, Lane, Avenue may be abbreviated as needed.

Refer to color coding exhibit and sign specifications for indication of colors and coatings. Background of band represents color coding, all lettering and numerals to be painted white in Helvetica Bold font as shown.

All applications of painted graphics receive top coat of clear anti-graffiti protection per MCDOT Sign Specifications. All coatings to be applied during warmer months to insure proper adhesion.



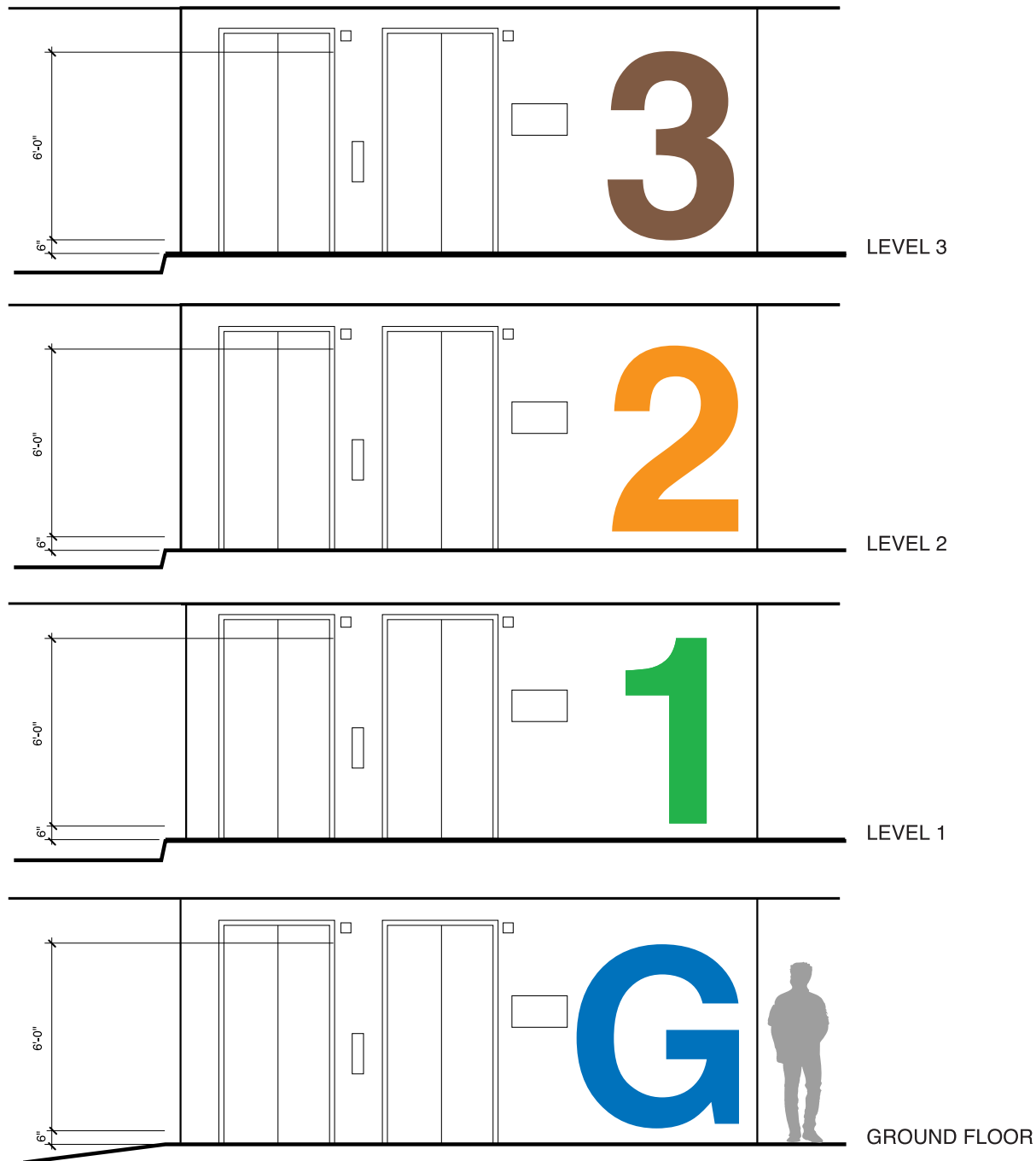

**PW3 - LEVEL NUMBER SUPER-GRAPHIC - FRONT VIEWS**

Super-graphics are painted in colors to follow pattern of level designation color coding. Supergraphics should appear at locations where wayfinding landmarks are necessary to the facility function and operation.

PW3 is a giant painted number or letter on the wall at 6'-0" or in sizes required to fit architectural conditions at the elevator lobby or stair core to provide better visibility from a distance.

Painted graphics are indicated on plans in dotted line form to express extent of painting. Graphics are indicated in sign message schedule and on plan with sign type (PW3) and "Level Number". Sizes and positions vary to suit conditions at the facility.

Coordinate graphics on architectural drawings in elevation and confirm conditions in the field. Pipes and conduit may interrupt murals but are often painted over to complete image.

Refer to color coding exhibit and sign specifications for indication of colors and coatings. Background of band represents color coding, all lettering and numerals to be painted white in Helvetica Bold font as shown.

All applications of painted graphics receive top coat of clear anti-graffiti protection per MCDOT Sign Specifications. All coatings to be applied during warmer months to insure proper adhesion.



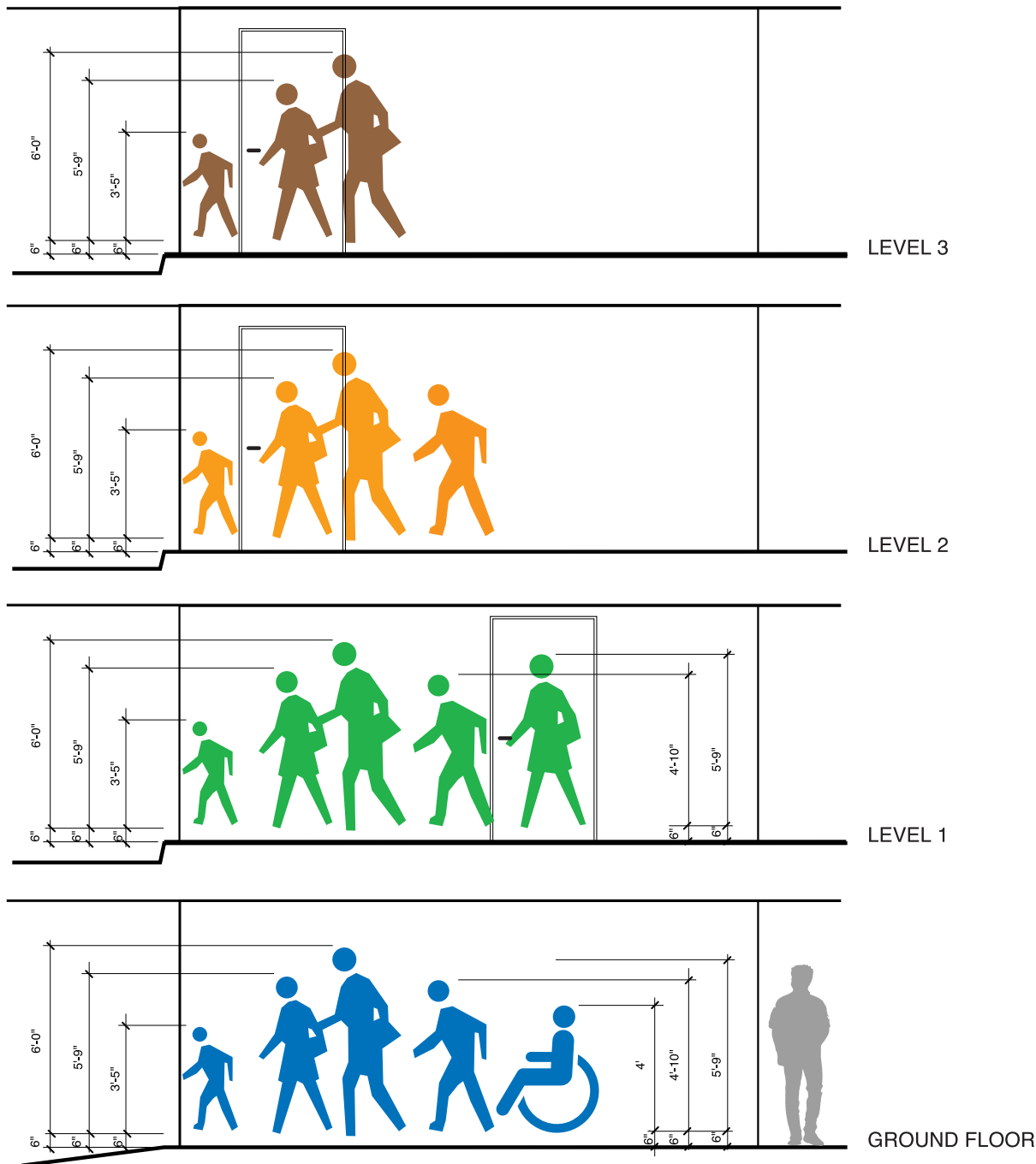

**PW4 - LOBBY LANDMARK PEOPLE - FRONT VIEWS**

Supergraphics are painted in colors to follow pattern of level designation color coding. Supergraphics should appear at locations where wayfinding landmarks are necessary to the facility function and operation.

PW4 is painted walking people symbols on the wall in sizes required to fit architectural conditions at the elevator lobby or stair core to provide better visibility from a distance.

Painted graphics are indicated on plans in dotted line form to express extent of painting. Graphics are indicated in sign message schedule and on plan with sign type (PW4) and "Lobby Landmark People". Sizes and positions vary to suit conditions at the facility.

Coordinate graphics on architectural drawings in elevation and confirm conditions in the field. Pipes and conduit may interrupt murals but are often painted over to complete image.

Refer to color coding exhibit and sign specifications for indication of colors and coatings. Background of band represents color coding, all lettering and numerals to be painted white in Helvetica Bold font as shown.

All applications of painted graphics receive top coat of clear anti-graffiti protection per MCDOT Sign Specifications. All coatings to be applied during warmer months to insure proper adhesion.

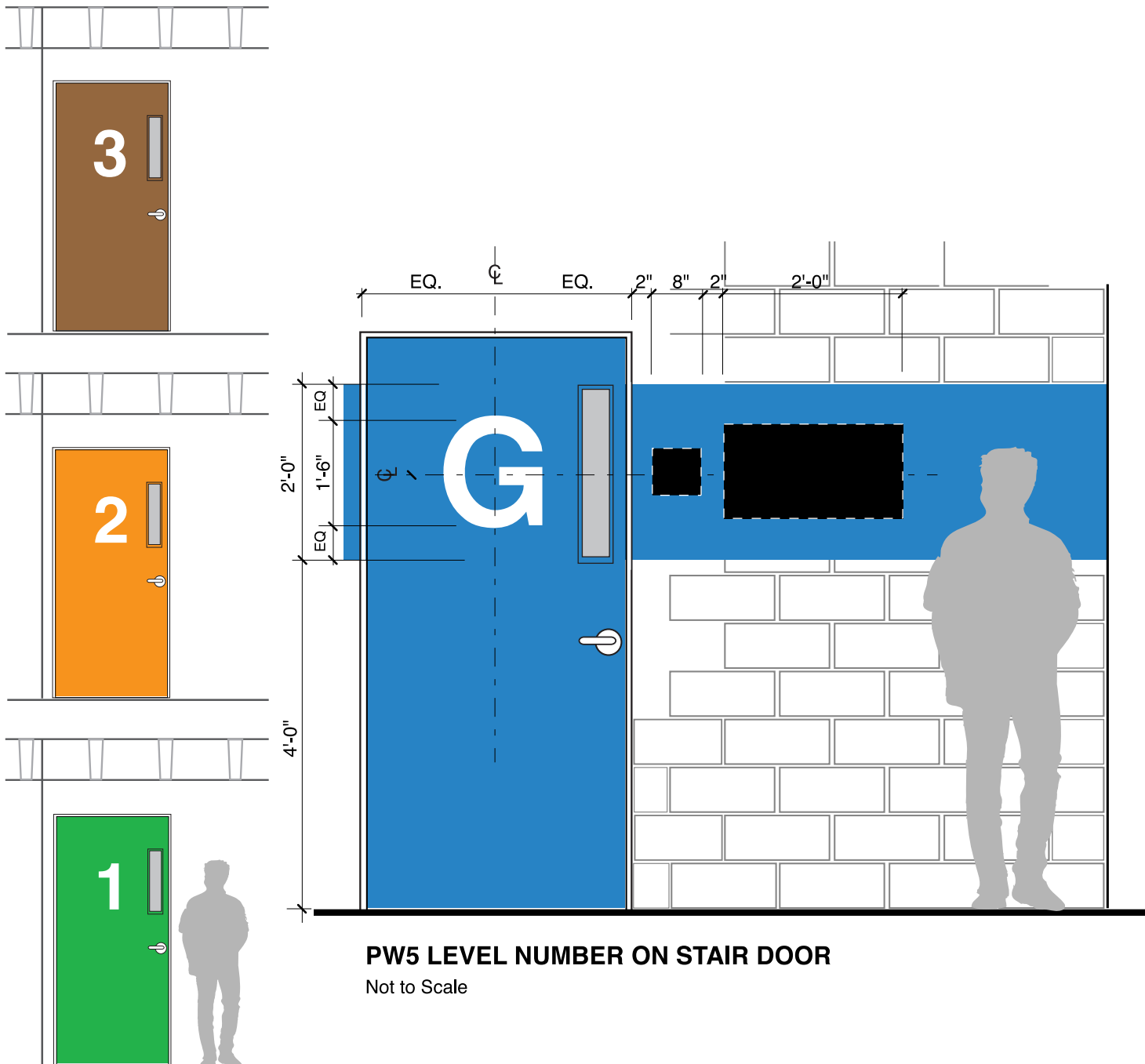

Graphics on stair doors are a part of super-graphics applications. All stair doors to receive level designation numerals and letters. Sign contractor to paint 24" wide color band & apply vinyl graphics to doors. Doors painted by MCDOT under separate contract.

Level designation letters and numerals to be white scotchlite reflective #280-10 vinyl - computer cut and adhered directly to door surface on center at 5'-0" above finished floor.

Typeface: Helvetica Bold - refer to font exhibits and match fonts exactly. Digital files available if necessary to make exact match.

Note: At window mounted sign condition, or on glass doors, plaques to have black vinyl back-up on reverse face to conceal mounting. Letters and numerals to be applied in translucent films.

Confirm sign locations and conditions at job site prior to fabrication, submission of shop drawings and installation.



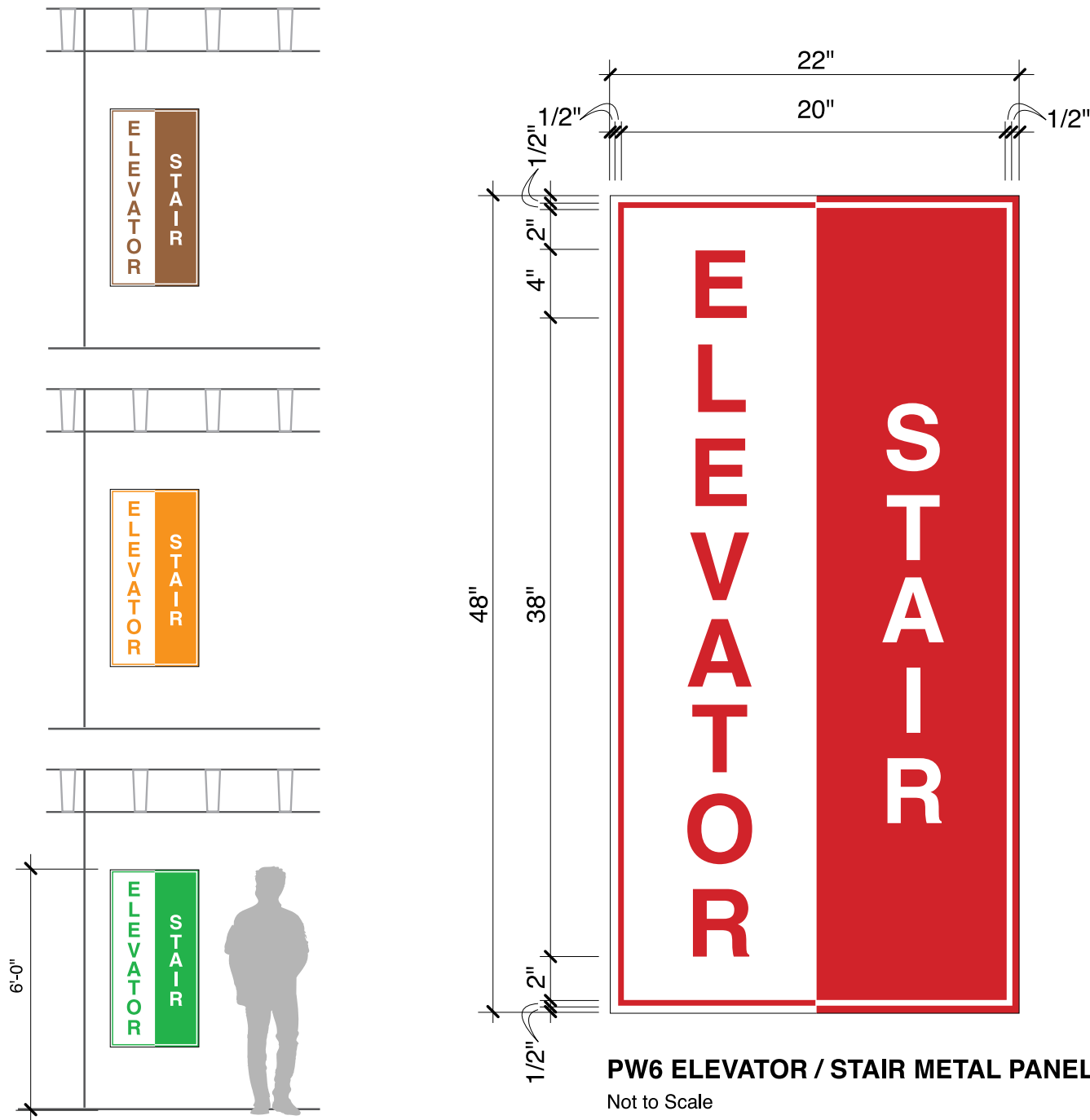

PW6 is precision cut aluminum.080" thick with edges and corners filed and eased to remove sharp. Not rounded, eased. All surfaces of panel, front & back to be primed & painted with acrylic polyurethane, glossy finish, in colors to coincide with color coding of levels.

Panels receive white reflective film graphics precision cut by computer and positioned as shown. Typeface: Helvetica Bold - refer to font exhibits and match fonts exactly. Digital files available if necessary to make exact match.

Note: Panels mount with concealed anchors into concrete, CMU walls and on steel vertical beams as required to provide visibility. Fasteners to be primed & painted out to match background. Positions of holes for fasteners to be confirmed before painting. Holes to be predrilled as required by mounting location.

Confirm sign locations and conditions at job site prior to fabrication, submission of shop drawings and installation.



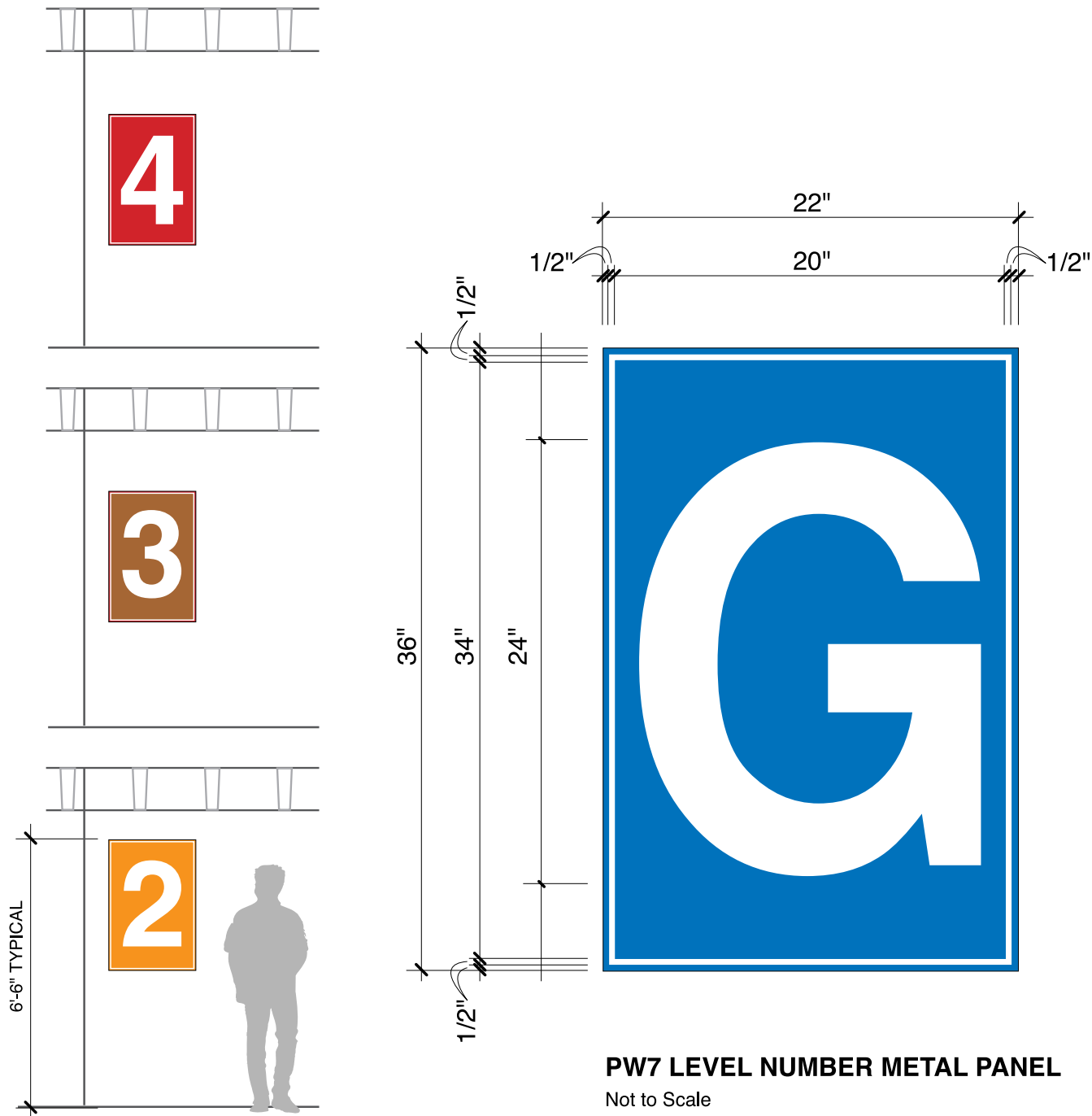

PW7 is precision cut aluminum.080" thick with edges and corners filed and eased to remove sharp. Not rounded, eased. All surfaces of panel, front & back to be primed & painted with acrylic polyurethane, glossy finish, in colors to coincide with color coding of levels.

Panels receive white reflective film graphics precision cut by computer and positioned as shown. Typeface: Helvetica Bold - refer to font exhibits and match fonts exactly. Digital files available if necessary to make exact match. PW7 is exception to "squeezing type" rule. G shown here is condensed to 90% for fitting. All other numerals to be normal width.

Note: Panels mount with concealed anchors into concrete, CMU walls and on steel vertical beams as required to provide visibility. Fasteners to be primed & painted out to match background. Positions of holes for fasteners to be confirmed before painting. Holes to be predrilled as required by mounting location.

Confirm sign locations and conditions at job site prior to fabrication, submission of shop drawings and installation.



10'- 0" VARIES

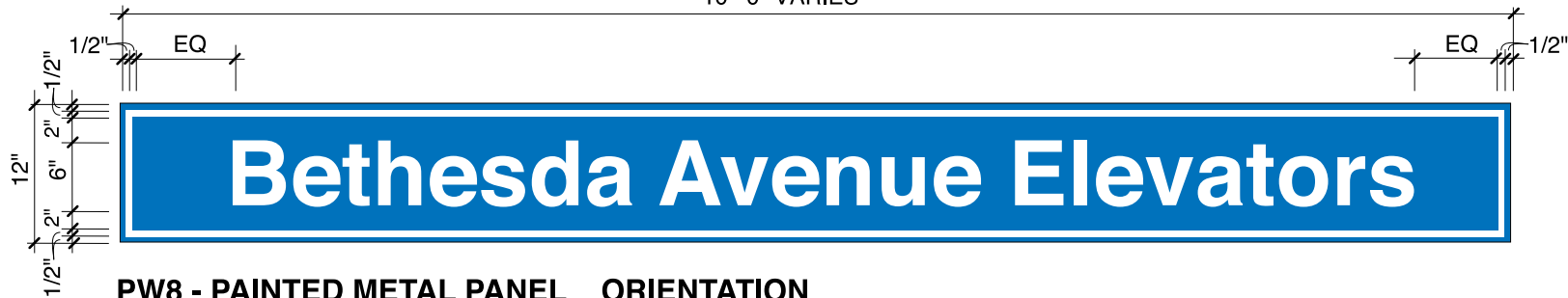

### PW8 - PAINTED METAL PANEL \_ ORIENTATION

Scale: 3/4" = 1'-0"

PW8 is precision cut aluminum.080" thick with edges and corners filed and eased to remove sharp. Not rounded, eased. All surfaces of panel, front & back to be primed & painted with acrylic polyurethane, glossy finish, in colors to coincide with color coding of levels.

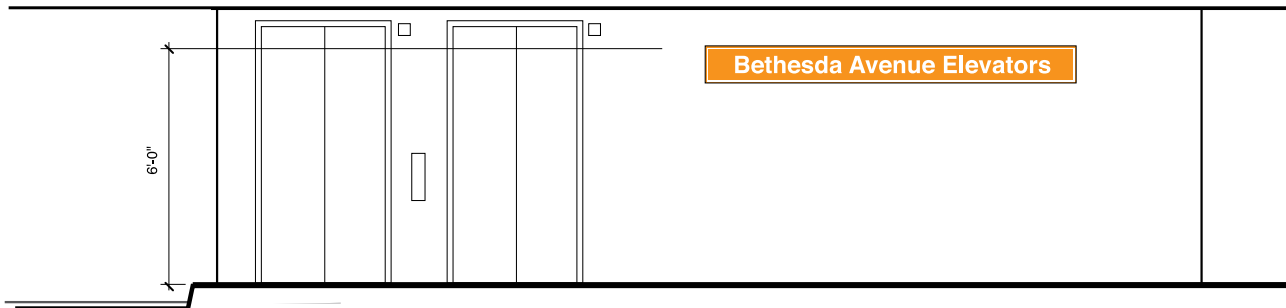

Panels receive white reflective film graphics precision cut by computer and positioned as shown. Typeface: Helvetica Bold - refer to font exhibits and match fonts exactly. Digital files available if necessary to make exact match. Verify desired street names with MCDOT prior to programming sign locations.

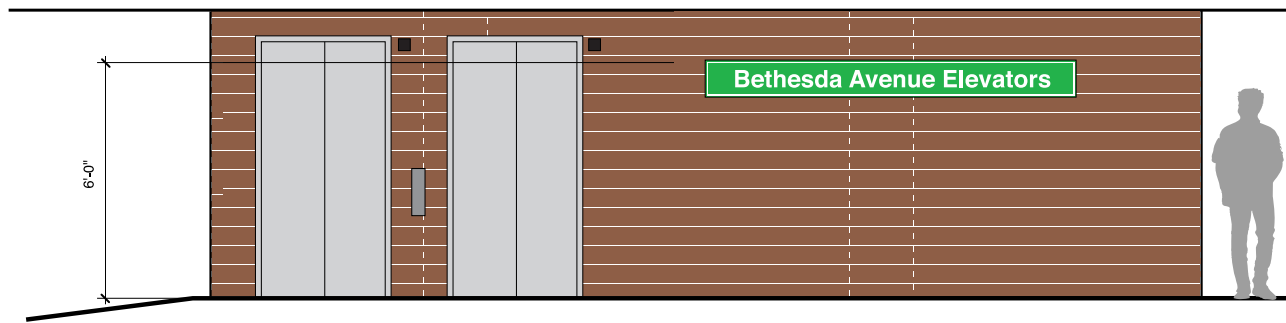

Note: Panels mount with concealed anchors into concrete, CMU walls and on steel beams as required to provide visibility. Fasteners to be primed & painted out to match background.

Confirm sign locations and conditions at job site prior to fabrication, submission of shop drawings and installation.

### PW8 - PAINTED METAL PANEL ORIENTATION - FRONT VIEWS



LEVEL 4  
AUBURN AVE  
STAIR

LEVELS G-4  
EXIT LEVEL G  
4 FLOORS DOWN

SPRING STREET  
STAIR

LEVEL G  
NOT AN EXIT

LEVEL 1  
SPRING STREET  
STAIR

EXIT HERE

WAVERLY  
STAIR

LEVEL 1  
TO ELEVATORS

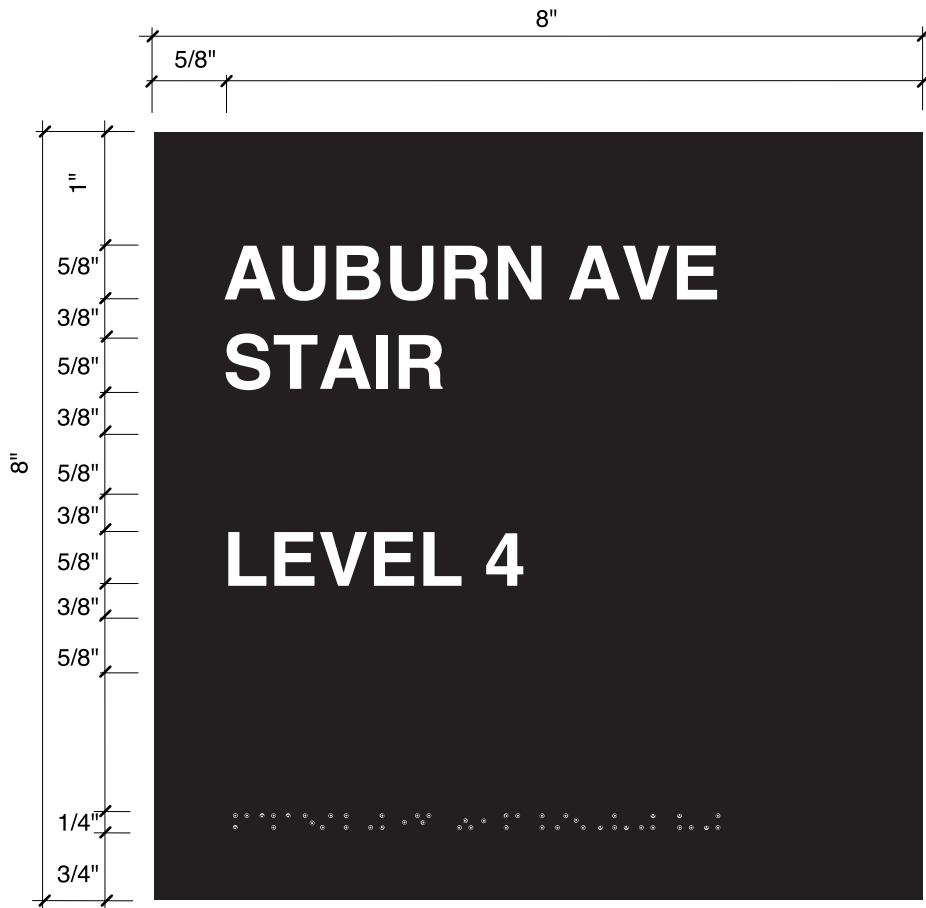

**PL1 - STAIR / LEVEL DESIGNATION - SIGN LAYOUTS**

Scale: 1/2" = 1"

OTHER LAYOUTS

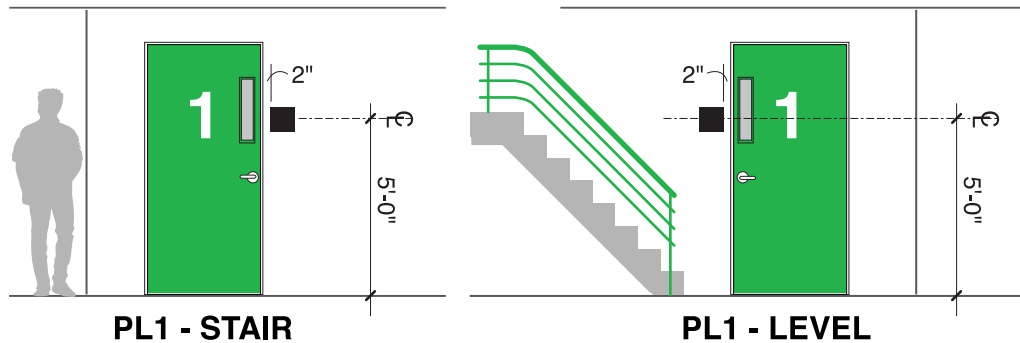

PL1 is ADA door marking at inside and outside of stair doors to identify stair & satisfy NFPA code requirements.

Plaques of exterior grade polymer laminated to 3/16" thick black acrylic backup for vandal-proof mounting. Back plate fastened to wall with 4 screws into expansion anchors 1" in from corners. Tactile plaque mounted to back-up with VHB tape all around.

Lettering & Grade II braille to be raised 1/32". Lettering to be painted white eggshell finish.

Grade II braille to be "painted out" with eggshell finish background-black. Edges are painted black. exterior grade polymer braille to be 95 shore D durometer hardness. Optional source JETUSA.

Signs are designed to satisfy code requirements. Sign fabricator to confirm conditions at each job site and satisfy message requirements in sign message schedule for MCDOT approval prior to fabrication and installation.

All signs mount at strike side of door, on wall, at 5'-0" to center of plaque above finished floor. Verify all street names and desired names with MCDOT prior to drafting sign message schedule.



**Level 2**  
 SPRING ST. AT  
 COLESVILLE RD. STAIR  
 LEVELS G THRU 3  
 EXIT LEVEL G  
 2 FLOORS DOWN

**Level 3**  
 COLESVILLE RD. STAIR  
 LEVELS G THRU 3  
 EXIT LEVEL G  
 3 FLOORS DOWN

OTHER LAYOUTS

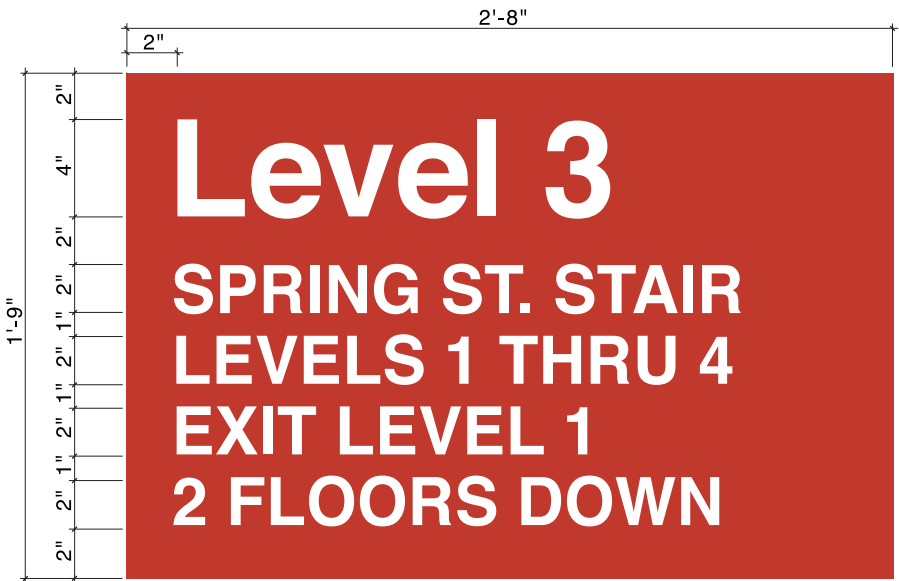

**PL2 - FIRE MARSHAL'S SIGN IN STAIRS - LAYOUT**

Scale: 1/8" = 1"

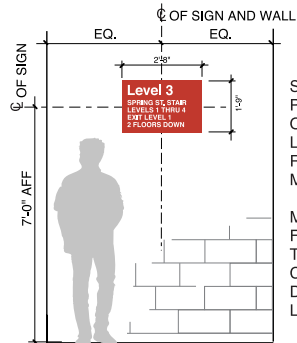

**PL2 - INSIDE STAIR**

SIGN TYPE PL2 TO BE POSITIONED AT 7'-0" AFF ON CENTER OF FLOOR LEVEL LANDING AS REQUIRED BY FIRE MARSHALL.

MCDOT TO BE PRESENT FOR PRE INSTALL WALK THROUGH. IF PIPES CONFLICT, MCDPWT WILL DETERMINE FINAL LOCATION.

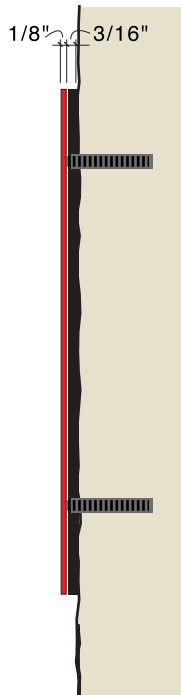

PL2 is designed to satisfy NFPA code requirements. Signs are installed at each landing inside a stair tower.

Plaques of 1/8" thick clear polycarbonate laminated to 3/16" thick black acrylic backup for vandal-proof mounting. Back plate fastened to wall with 4 screws into expansion anchors 1" in from corners. Plaque mounted to back-up with VHB tape all around.

Lettering to be silk-screened in white or white film precision cut by computer and reverse-applied to face for subsurface appearance. Typeface: Helvetica Bold C/LC as shown.

Background sprayed Geranium Red to conceal mounting to backer panel. White and red colors to be opaque and solid.

Sign fabricator to confirm conditions at each stair tower at job site and satisfy message requirements in sign message schedule for MCDOT approval prior to fabrication and installation.

All signs mount to wall, at 7'-0" to center of plaque above finished floor. Verify all street names and desired names with MCDOT prior to drafting sign message schedule.



**PL3 - ELEVATOR LOBBY PLAQUE - LAYOUT**

Scale: 3/16" = 1"

PL3 is designed to satisfy elevator code requirements. Signs are installed at each elevator lobby above call buttons.

Plaques of 1/8" thick clear polycarbonate laminated to 3/16" thick black acrylic backup for vandal-proof mounting. Back plate fastened to wall with 4 anchors 1" in from corners. Plaque mounted to back-up with VHB tape all around.

All edges and corners filed smooth and eased to remove sharp. Not rounded, eased.

Lettering & symbols to be silk-screened in White & Geranium Red reverse-applied to face for subsurface appearance. Typeface: Helvetica Bold C/LC as shown.

Background sprayed Black to conceal mounting to backer panel. White and red colors to be opaque and solid.

Part B is not used at 24 hour facilities. Verify operation with MCDOT prior to program-ming sign messages for MCDOT approval prior to fabrication and installation.

All signs mount to wall, at 5'-0" to center of plaque above finished floor, centered on painted band if present. Sign systems are designed so components fit together consistently from floor-to-floor.

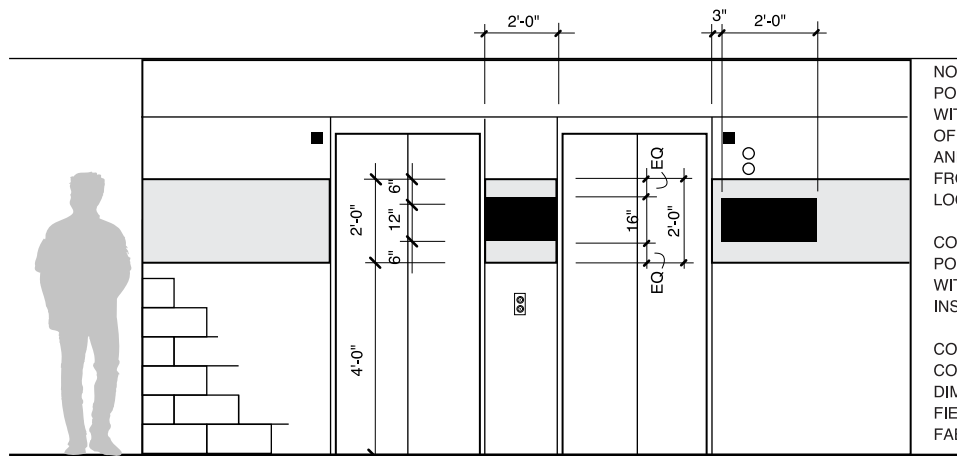

**PL3 - ELEVATOR LOBBY PLAQUE WITH RELATED ELEMENTS**

NOTE: SIGNS ARE POSITIONED TO FIT WITHIN APPLICATIONS OF SUPER-GRAPHICS, AND TO BE CONSISTENT FROM LOCATION TO LOCATION.

CONFIRM EXACT POSITIONS OF ALL SIGNS WITH MCDOT PRIOR TO INSTALLATION.

CONFIRM INSTALLATION CONDITIONS AND DIMENSIONS IN THE FIELD PRIOR TO FABRICATION.



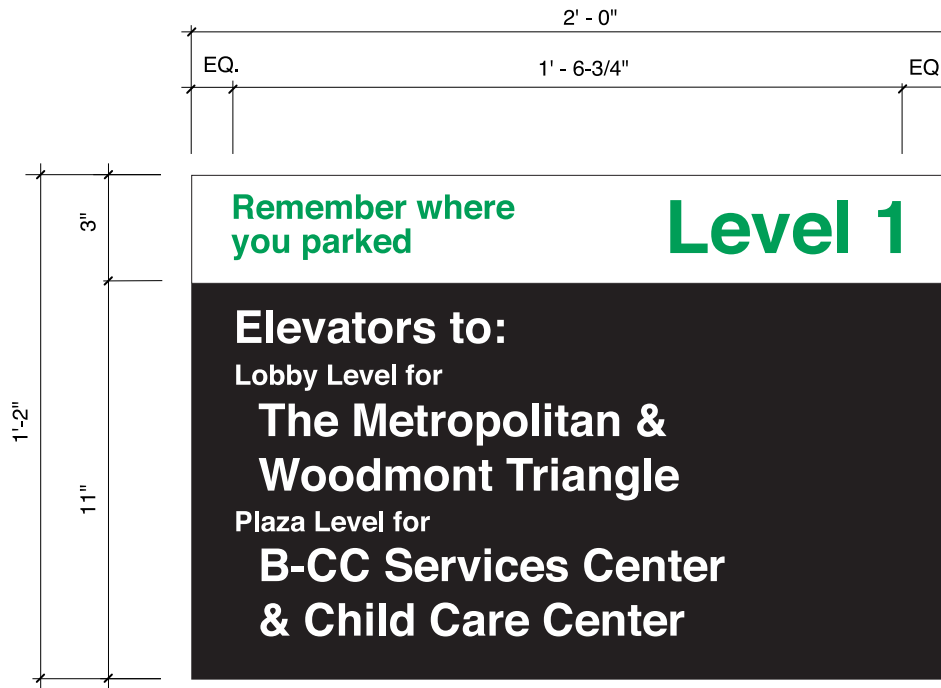

**PL4 - WAYFINDING INFORMATION PLAQUE WITH COLOR**  
Scale: 3/16" = 1"

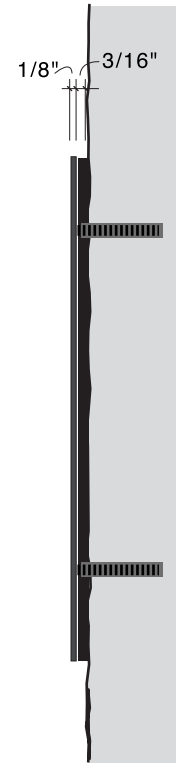

PL4 is designed to assist customers in orientation and wayfinding. Signs are installed at each elevator lobby in locations adjacent elevator cabs or at Stair towers as needed.

Message at top is consistent and coincides with level color designations. White copy on lower field provides pedestrian oriented directional information where needed.

Plaques of 1/8" thick clear polycarbonate laminated to 3/16" thick black acrylic backup for vandal-proof mounting. Back plate fastened to wall with 4 expansion sleeve anchors 1" in from corners. Plaque mounted to back-up with VHB tape all around. All edges and corners filed smooth and eased to remove sharp. Not rounded, eased.

Lettering to be silk-screened in White & colors reverse-applied to face for subsurface appearance. Typeface: Helvetica Bold C/LC as shown.

Background sprayed Black and White to conceal mounting to backer panel. White and copy colors to be opaque and solid.

All signs mount to wall, at 5'-0" to center of plaque above finished floor, centered on painted band if present. Sign systems are designed so components fit together consistently from floor-to-floor.

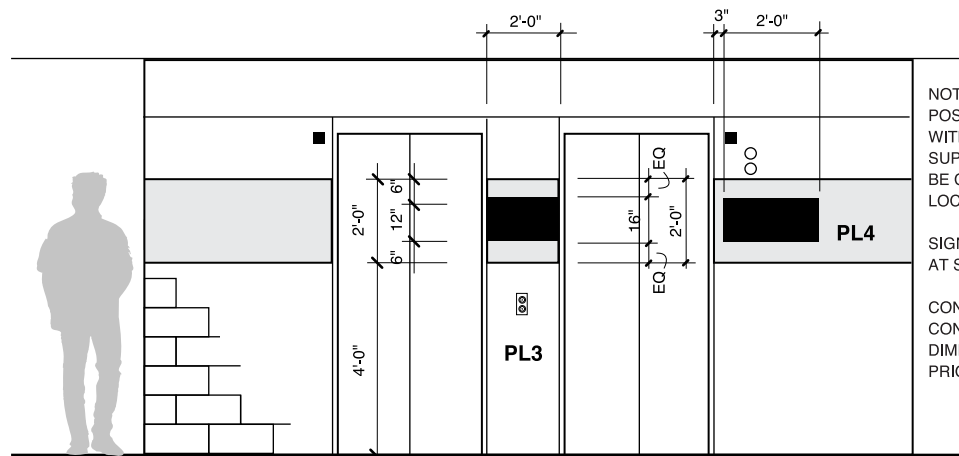

**PL4 - WAYFINDING INFO PLAQUE WITH RELATED ELEMENTS**



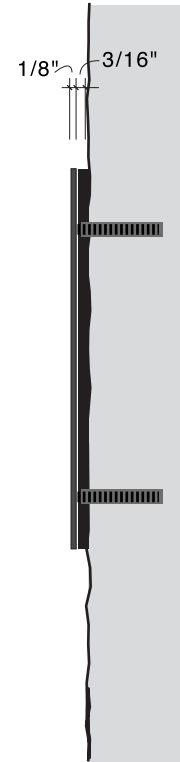
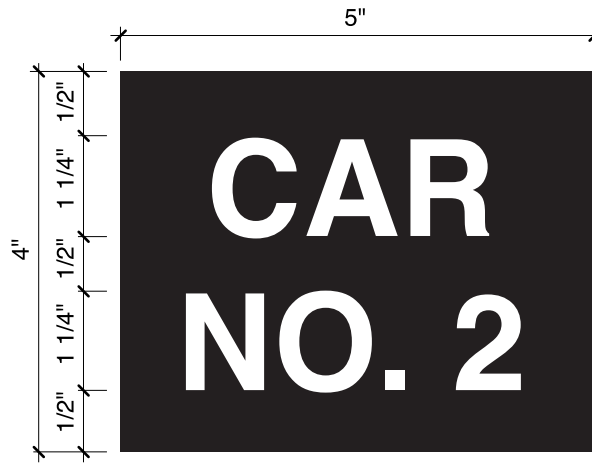

**PL5 - ELEVATOR CAB NUMBER LABELS**

Scale: 1/2" = 1"

PL5 is designed to satisfy elevator code. Signs are installed at each elevator lobby in locations adjacent elevator cabs as shown.

MCDOT will confirm elevator designations.

Plaques of 1/8" thick clear polycarbonate laminated to 3/16" thick black acrylic backup for vandal-proof mounting. Back plate fastened to wall with 2 expansion sleeve anchors 1" in from corners. Plaque mounted to back-up with VHB tape all around. All edges and corners filed smooth and eased to remove sharp. Not rounded, eased.

Lettering to be silk-screened in White reverse-applied to face for subsurface appearance. Typeface: Helvetica Bold C/LC as shown.

Background sprayed Black to conceal mounting to backer panel. White copy to be opaque and solid.

All signs mount to wall, 3" from elevator door frame, to align with top of door frame.

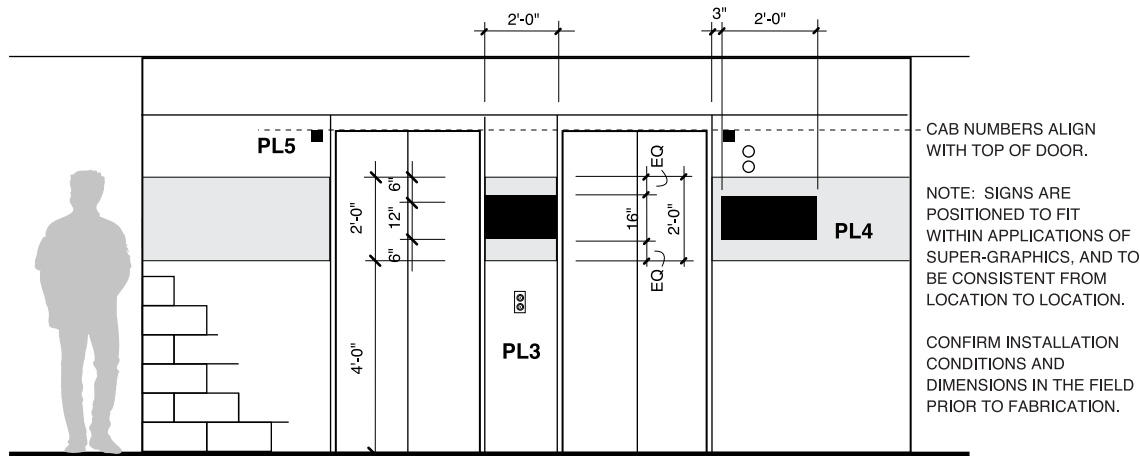

**PL5 - ELEVATOR CAN NUMBER LABELS WITH RELATED ELEMENTS**



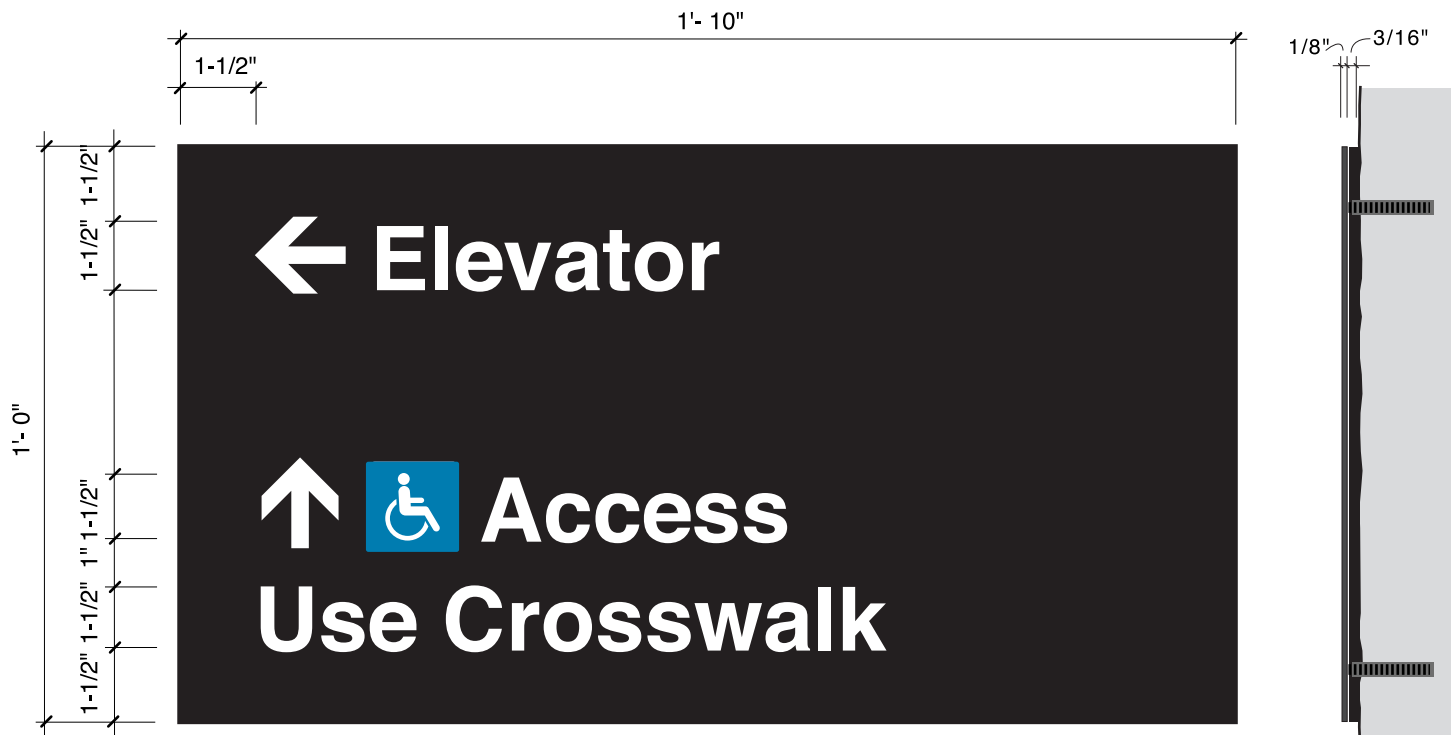

**PL6 - ACCESSIBLE ROUTE MARKING**

Scale: 1/4" = 1"

PL6 is designed to satisfy ADA requirements. Braille is not required for this sign type. Signs are installed at any elevator lobby where obstructions to access demand turns to reach pathway or ramp.

MCDOT will confirm elevator accessibility.

Plaques of 1/8" thick clear polycarbonate laminated to 3/16" thick black acrylic backup for vandal-proof mounting. Back plate fastened to wall with 4 anchors 1" in from corners. Plaque mounted to back-up with VHB tape all around. All edges and corners filed smooth and eased to remove sharp. Not rounded, eased.

Lettering to be silk-screened in White reverse-applied to face for subsurface appearance. Typeface: Helvetica Bold C/LC as shown. HC Symbol background to be Pantone 300 Blue. (DOT=280-76)

Background sprayed Black to conceal mounting to backer panel. White copy to be opaque and solid.

All signs mount to wall, 5'-0" to center of plaque above finished floor, in position as required to delineate pathway of accessibility.

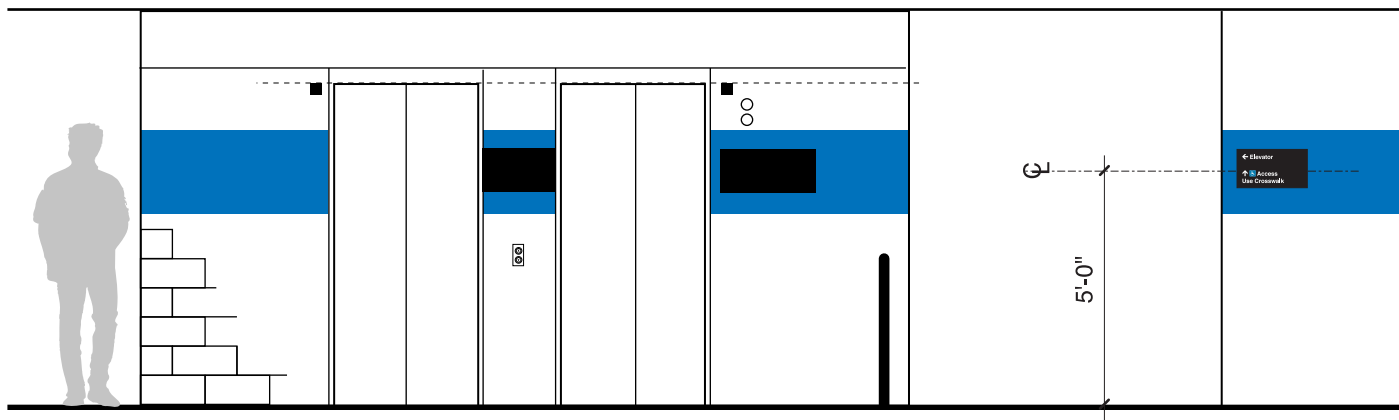

**PL6 - ACCESSIBLE ROUTE MARKING**



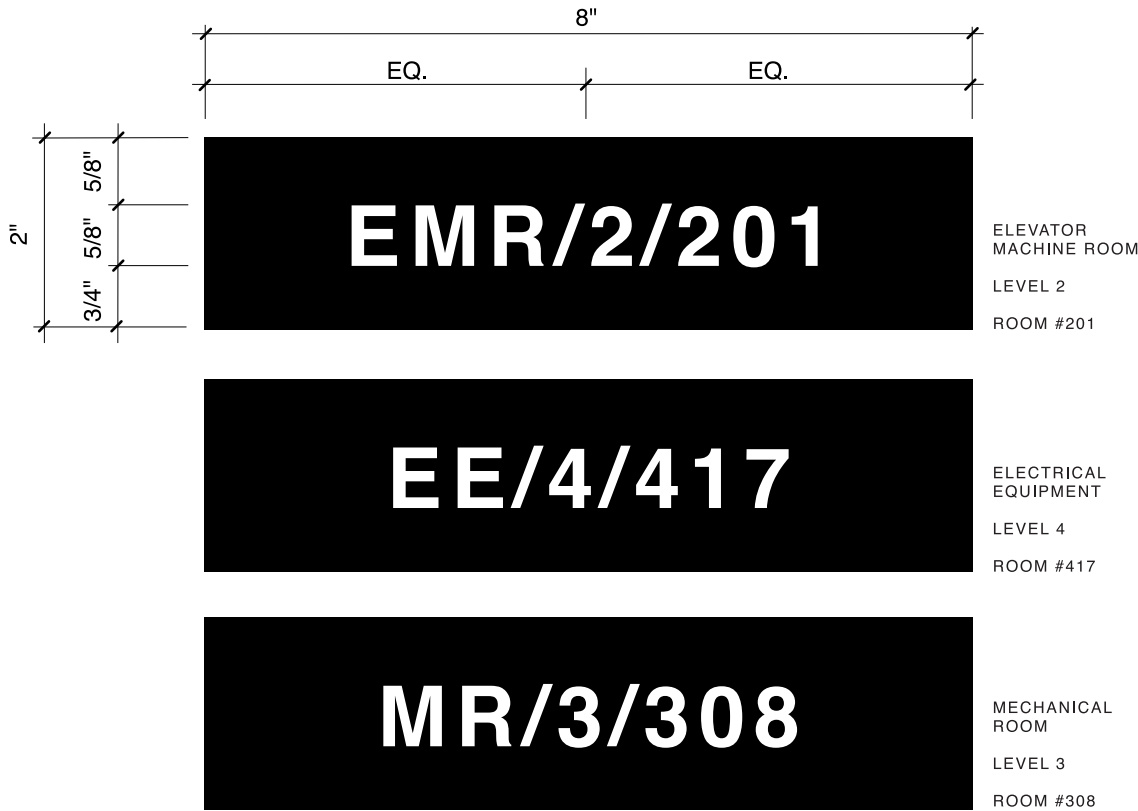

**PL7 - BASE BUILDING DOOR SIGNS**

Scale: 1/2" = 1"

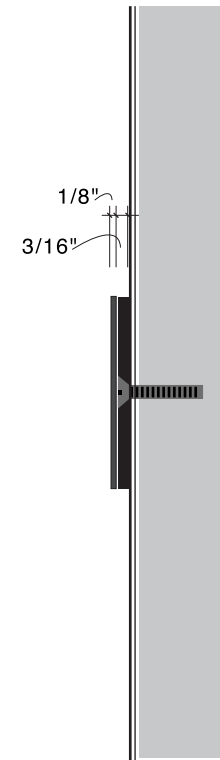

PL7 is designed to identify non-public doors. Braille is not required for this sign type. Signs are installed on or beside doors as MCDOT directs.

MCDOT will provide room numbers.

Plaques of 1/8" thick clear polycarbonate laminated to 3/16" thick black acrylic backup for vandal-proof mounting. Back plate fastened to wall with 4 anchors 1" in from corners. Plaque mounted to back-up with VHB tape all around. All edges and corners filed smooth and eased to remove sharp. Not rounded, eased.

Lettering to be silk-screened in White reverse-applied to face for subsurface appearance. Typeface: Helvetica Bold as shown.

Background sprayed Black to conceal mounting to backer panel. White copy to be opaque and solid.

Messages represent room type / level designation / room number as determined by MCDOT.

All signs mount to wall, 5'-0" to center of plaque above finished floor, in position as required to provide uniform appearance.

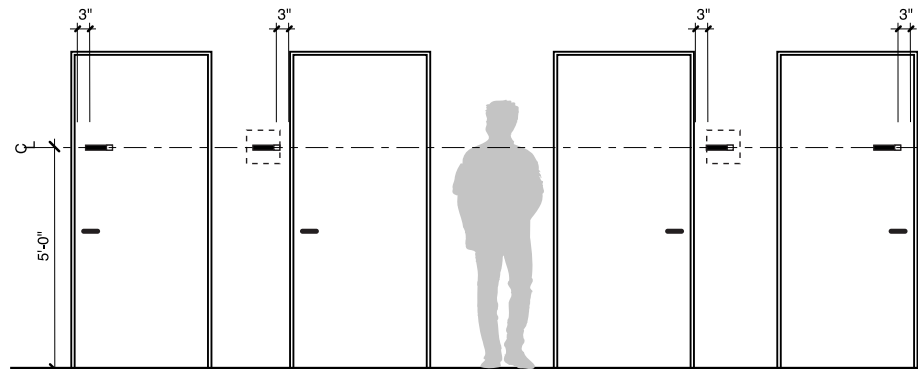

**PL7 - BASE BUILDING DOOR SIGNS - TYPICAL LOCATIONS**



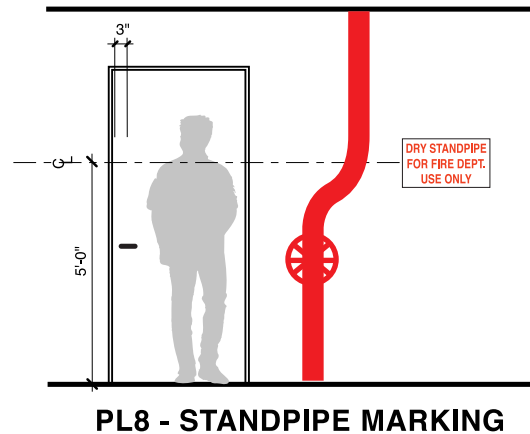
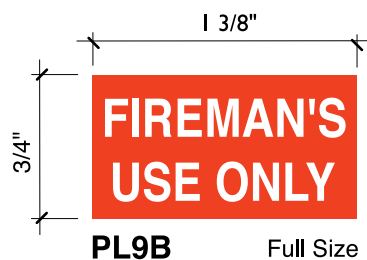
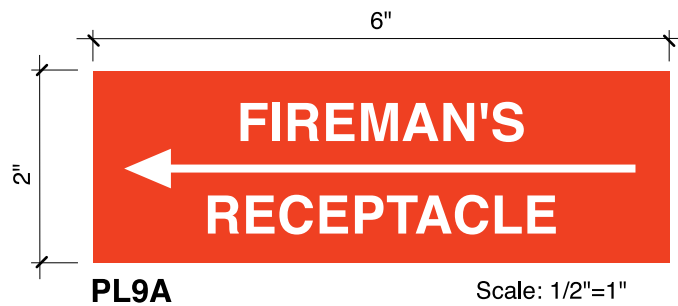

Regulatory signs to satisfy Fire Marshal's code requirement, to be installed as indicated on drawings and sign location plans, or as indicated in reports following coordination meetings with representatives from the fire department.

Sign fabricator to confirm requirements. Signs may be provided by others. Coordinate efforts with MCDOT prior to drafting of sign message schedule and sign location plans.

Plaques to be fabricated of 1/8" thick phenolic engraving stock. Sign PL8 is white with red core, sign types PL9A and PL9B are red with white core.

Note: Red to emulate Geranium red in closest standard color. Provide sample for MCDOT approval prior to engraving.

Signs to be mounted permanently with VHB tape and silicon adhesive to follow substrate adhesion requirements, with mechanical fasteners if required by MCDOT.

Lettering and arrows to be engraved into sign plaque surface 1/32" depth. Typeface: Helvetica Bold, sized as shown.



**PL10 AREA OF RESCUE ASSISTANCE SIGN**  
SCALE: 3/8"=1"



ADA marking plaques of polymer, exterior grade pva/urethane base composition laminated to 3/16" thick black acrylic back-up for vandal-proof mounting. Plaques may be manufactured of JET-388-EX by JET USA CORP. 800-528-1153

Lettering & Grade II Braille to be raised 1/32". Lettering to be painted white matte finish. Grade II Braille to be 'painted out' with eggshell finish background-black. Exterior grade polymer to be 95 shore D durometer hardness. Note: Edges painted black.

Plaques to be mounted in locations as indicated by engineers on plans, at 48" to center above floor.

Sign fabricator to submit sign message schedule for confirmation of exact quantities and nomenclature. ADA signs require all capital letters.

Note: HC symbol artwork may be provided. White symbol to appear on blue background. Symbol field and artwork to be silk-screened. Blue to match 300 Blue. (DOT=280-76)

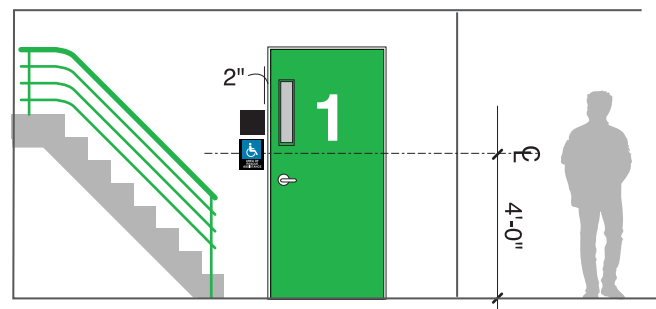

**PL10 - AREA OF RESCUE ASSISTANCE SIGN**









**CO3 - RESTROOM PLAQUE - TYPICAL**  
SCALE: 3/8"=1"

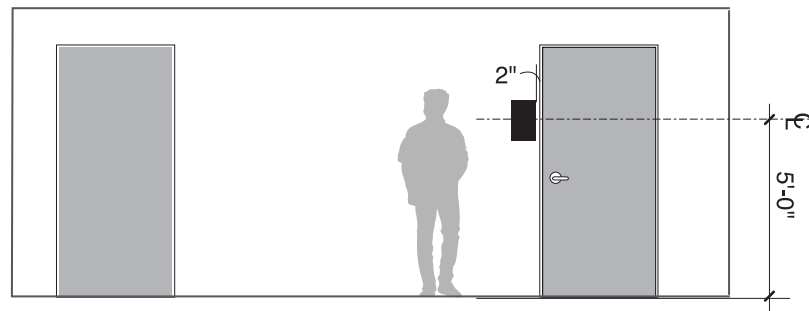

**CO3 - RESTROOM PLAQUE - SIGN LOCATION**

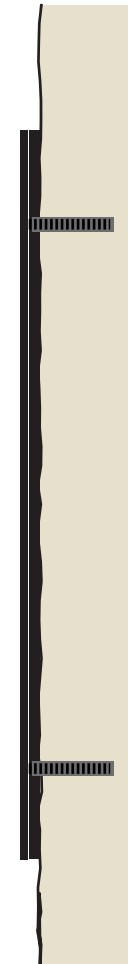

ADA marking plaques of polymer, exterior grade pva/urethane base composition laminated to 3/16" thick black acrylic back-up for vandal-proof mounting. Plaques may be manufactured of JET-388-EX by JET USA CORP. 800-528-1153

Lettering, symbols & Grade II Braille to be raised 1/32". Lettering to be painted white matte finish.

Grade II Braille to be 'painted out' with eggshell finish background-black. Exterior grade polymer to be 95 shore D durometer hardness. Note: Edges painted black.

Plaques to be mounted in locations as indicated by engineers on plans, at 48" to center above floor.

Sign fabricator to submit sign message schedule for confirmation of exact quantities and nomenclature. ADA signs require all capital letters.

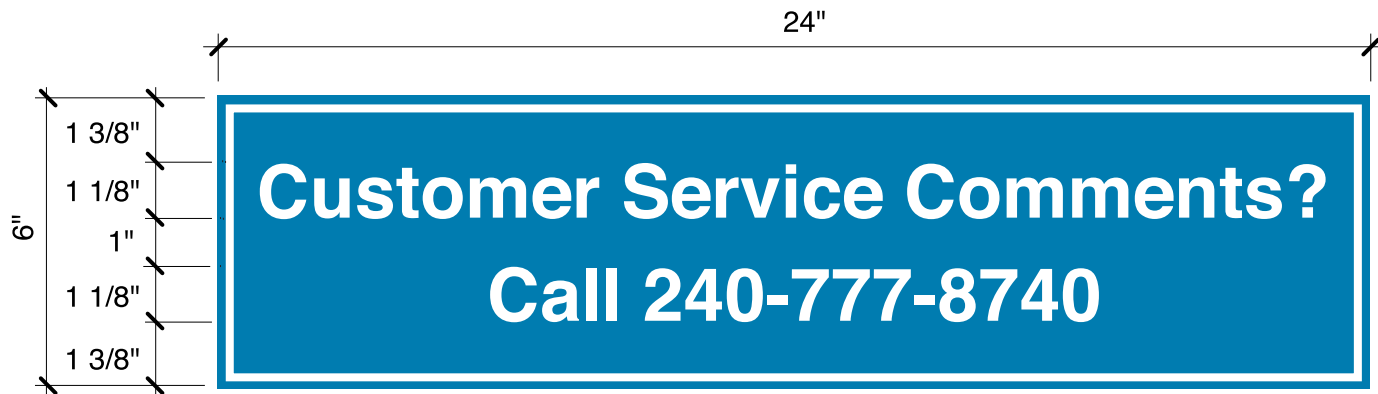

**CO4A**

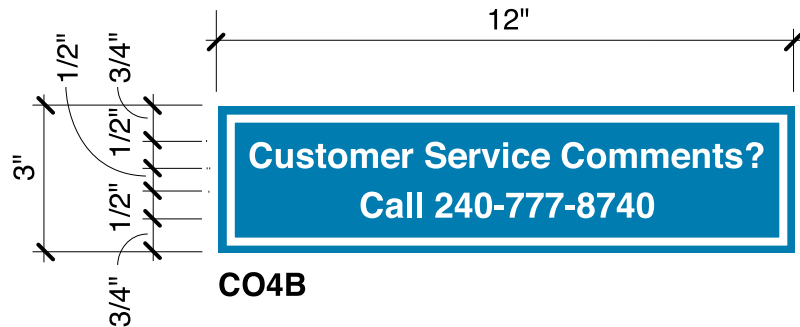

**CO4B**

**CO4 CONTACT INFORMATION - TYPICAL**

SCALE: 1/4"=1"

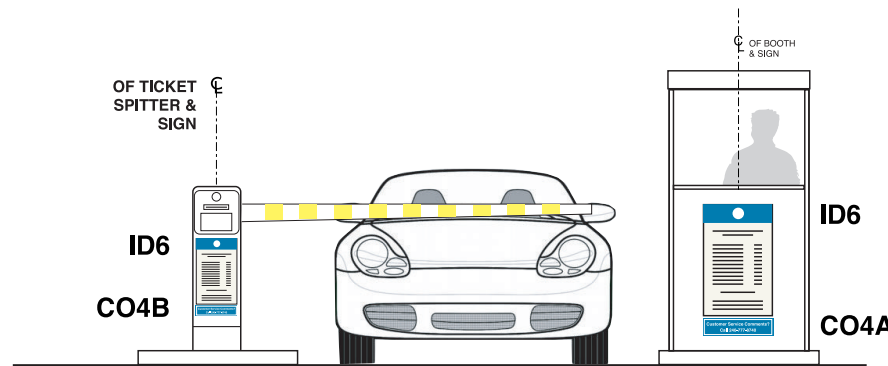

**CO4 CONTACT INFORMATION - SIGN LOCATION**

Signs to be fabricated of .080 aluminum with eased corners and filed edges - no sharp. Corners are not rounded - they are eased.

All surfaces of panel to be primed and painted eggshell finish with acrylic polyurethane to match 300 Blue.

Lettering and borders to be silkscreened white to match per rates sign types ID6.

Note: Confirm exact sign locations with MCDOT prior to installation. In all cases fasteners and mechanical attachment to be concealed if possible. Signs may be installed with VHB tape all around if surface will allow.

Verify message (phone number) with MCDOT prior to fabrication.



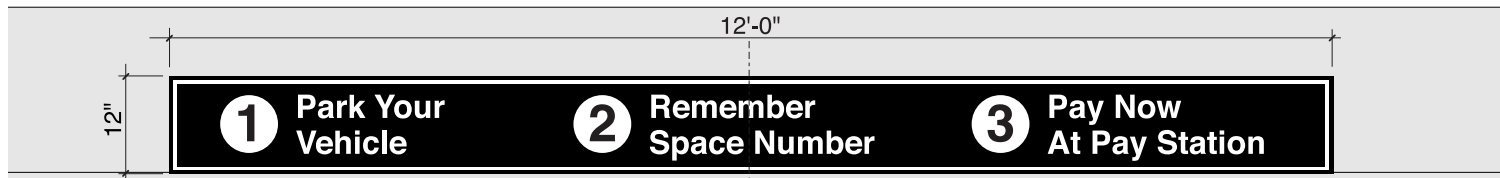

**MS1 OVERHEAD INSTRUCTIONS LAYOUT TYPICAL**

SCALE: 3/4"=1'-0"

OVERHEAD SIGNS MOUNT TO BRICK WALLS, CONCRETE BEAMS AND PAINTED STEEL I-BEAMS AS SHOWN ON SIGN LOCATION PLANS AND SIGN MESSAGE SCHEDULE. PANELS MOUNT TO BRICK AND CONCRETE BEAMS WITH HILTI METAL HIT ANCHORS #5403020 ON 24" CENTERS ALONG TOP AND BOTTOM EDGES OF SIGNS, 3/4" IN FROM EDGES OF SIGNS AS SHOWN.

SIGN CONTRACTOR TO X-RAY EACH CONCRETE BEAM (AND CEILING MOUNTED HANGING SIGN) LOCATIONS TO CONFIRM LOCATION OF REBAR (POST-TENSIONED STRANDS) WITHIN. 1" DEPTH FASTENERS APPROVED BY MCDPWT FOR USE, BUT NOT TO HIT REBAR.

PANELS MOUNT TO PAINTED STEEL BEAMS WITH DF TAPE AND ADHESIVE AS RECOMMENDED BY MANUFACTURER FOR SECURE ATTACHMENT OF PAINTED METAL OBJECT. BACK AND EDGES OF SIGNS PAINTED TO MATCH FACE.

**OVERHEAD BEAM MOUNTED SIGN INSTALL DETAILS - TYPICAL**

SCALE: 3/16"=1'-0"

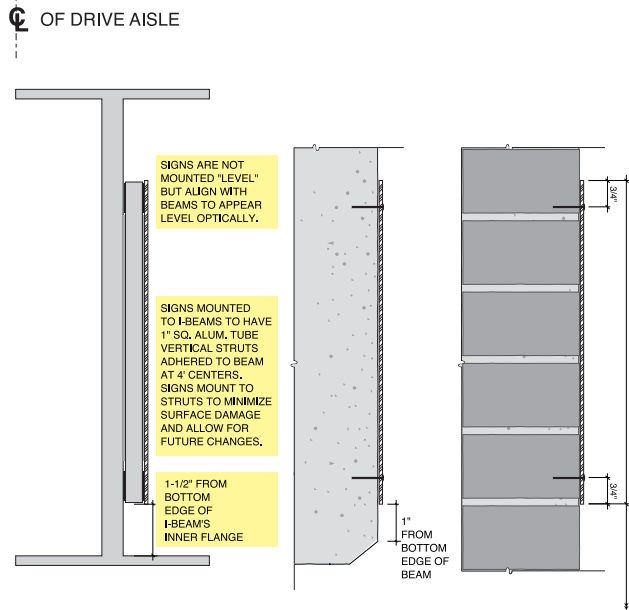

12 foot long MS1 instruction sign panels are centered above drive aisles at logical intervals on all levels of a "Multi-Space" garage. Fabrication and layout are similar to Type DR12 signs.

Signs to be custom fabricated of .080 alum. with edges & corners filed & eased. No sharp edges or surfaces. All surfaces, front, back & sides to be primed & painted black, egg shell finish with acrylic polyurethane.

All lettering & number fields to be white reflective film per MCDOT specifications. Typeface: Helvetica Bold upper/lower case as shown.

Note: Face panels mount to concrete beams and welded steel frames at double faced conditions. all fasteners to be primed & "painted out" to match black background. MS1 signs may also be hanger mounted if necessary for visibility.

All sign locations are to be confirmed with MCDOT at jobsite prior to drafting shop drawing submissions or installing signs.

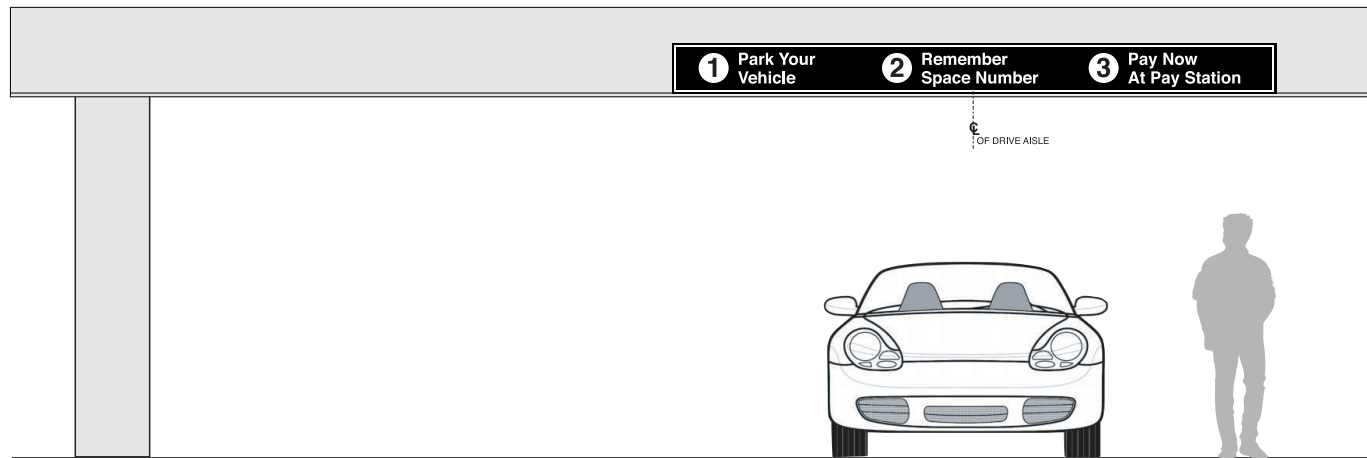

**MS1 OVERHEAD INSTRUCTIONS - SIGN LOCATION**



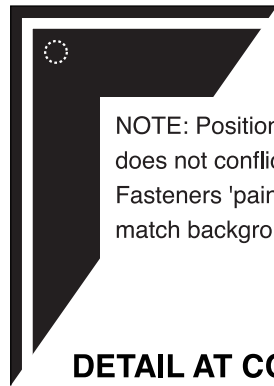

**DETAIL AT CORNER**

**MS2 WALL / COLUMN INSTRUCTIONS  
LAYOUT TYPICAL**

SCALE: 1"=1'-0"

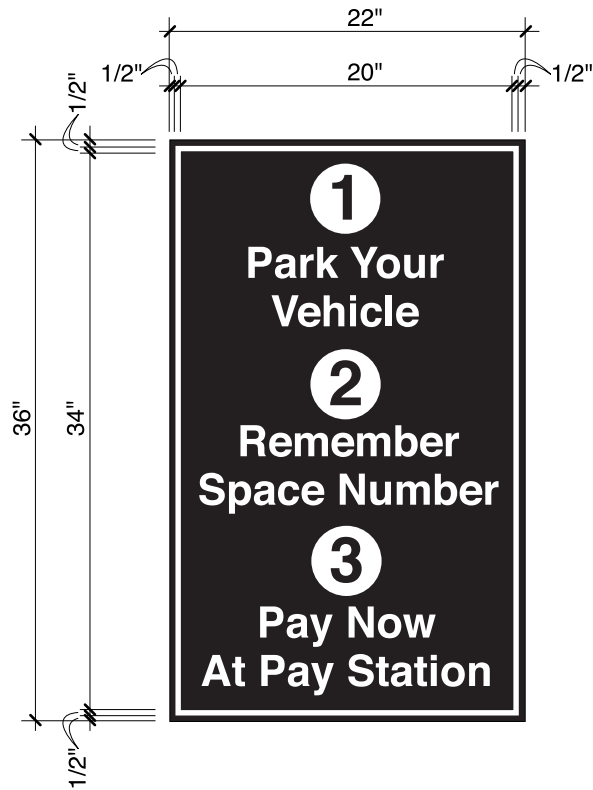

MS2 Instruction sign panels are mounted to columns and walls at logical intervals on all levels of a "Multi-Space" garage. Fabrication and layout are similar to Type MS3 signs.

Signs to be custom fabricated of .080 alum. with edges & corners filed & eased. No sharp edges or surfaces. All surfaces, front, back & sides to be primed & painted black, egg shell finish with acrylic polyurethane.

All lettering & number fields to be white reflective film per MCDOT specifications. Typeface: Helvetica Bold upper/lower case as shown.

Note: Face panels mount to concrete columns and / or steel columns or walls. All fasteners to be primed & "painted out" to match black background. Minimum 4 fasteners into anchors on concrete, minimum 2 fasteners through BandIt® on steel columns (4 preferred).

All sign locations are to be confirmed with MCDOT at jobsite prior to drafting shop drawing submissions or installing signs.

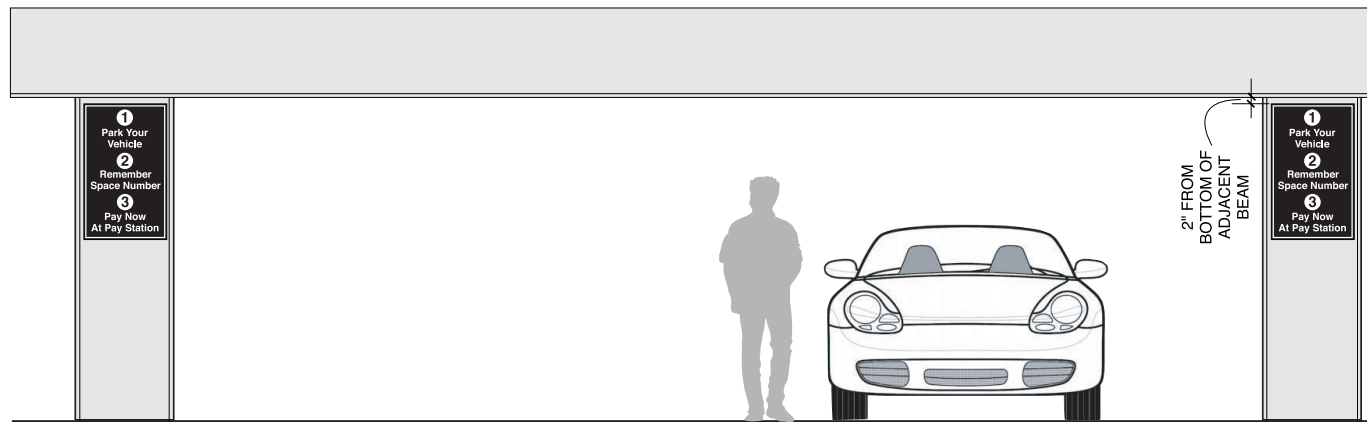

**MS2 WALL / COLUMN INSTRUCTIONS - SIGN LOCATION**



**MS3 DIRECTIONAL REMINDER  
LAYOUT TYPICAL**

SCALE: 1"=1'-0"



MS3 Directional Reminder sign panels are mounted to columns and walls at logical intervals on all levels of a "Multi-Space" garage. Fabrication and layout are similar to Type MS2 signs.

Signs to be custom fabricated of .080 alum. with edges & corners filed & eased. No sharp edges or surfaces. All surfaces, front, back & sides to be primed & painted black, egg shell finish with acrylic polyurethane.

All lettering, symbols and arrows to be white reflective film per MCDOT specifications. Typeface: Helvetica Bold upper/lower case as shown.

Note: Face panels mount to concrete columns and / or steel columns or walls. All fasteners to be primed & "painted out" to match black background.

Directional arrows vary by location depending on position of Pay Station.

All sign locations are to be confirmed with MCDOT at jobsite prior to drafting shop drawing submissions or installing signs.

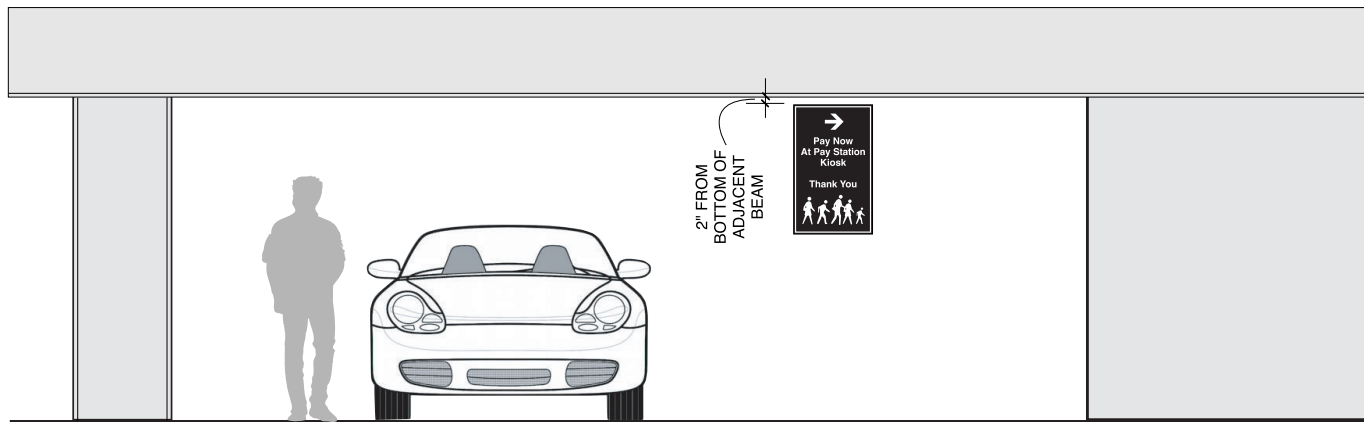

**MS3 DIRECTIONAL REMINDER - SIGN LOCATION**



**MS4 PAY STATION LOCATION SIGN  
LAYOUT TYPICAL**

SCALE: 1"=1'-0"

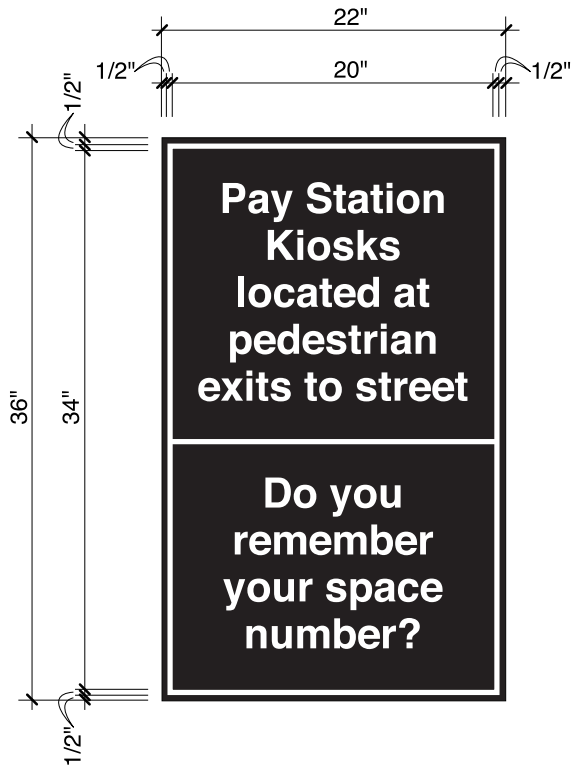

MS4 Pay Station Location sign panels are mounted to columns and walls at logical intervals on all levels of a "Multi-Space" garage. Fabrication and layout are similar to Type MS3 signs.

Signs to be custom fabricated of .080 alum. with edges & corners filed & eased. No sharp edges or surfaces. All surfaces, front, back & sides to be primed & painted black, egg shell finish with acrylic polyurethane.

All lettering & borders to be white reflective film per MCDOT specifications. Typeface: Helvetica Bold upper/lower case as shown.

Messages will vary depending on location of Pay Stations. Verify as built conditions before programming sign messages.

Note: Face panels mount to concrete columns and / or steel columns or walls. All fasteners to be primed & "painted out" to match black background.

All sign locations are to be confirmed with MCDOT at jobsite prior to drafting shop drawing submissions or installing signs.

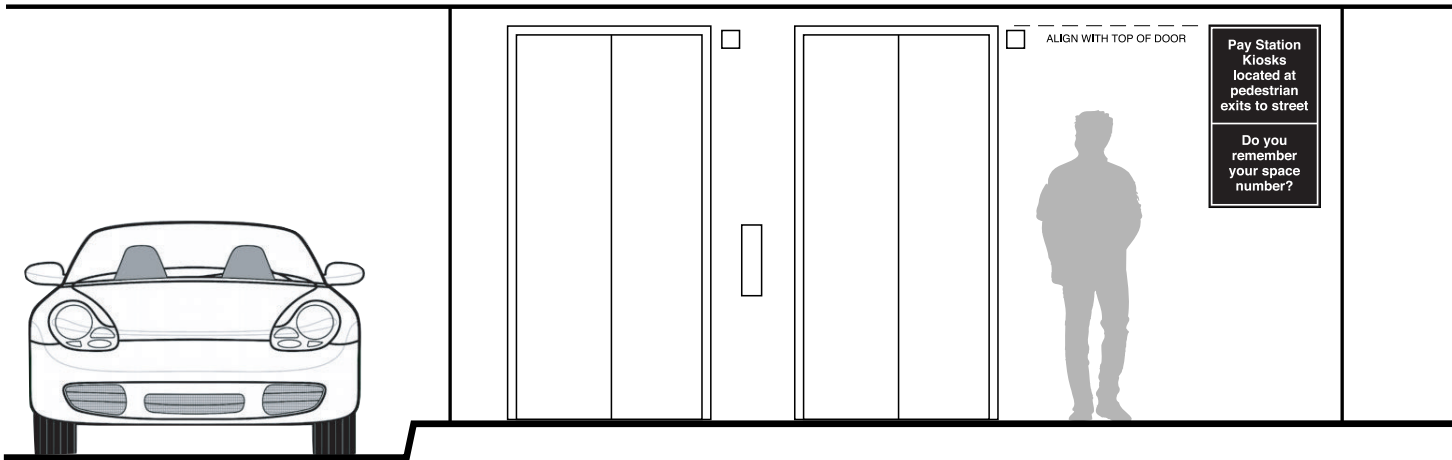

**MS4 PAY STATION LOCATION SIGN - SIGN LOCATION**



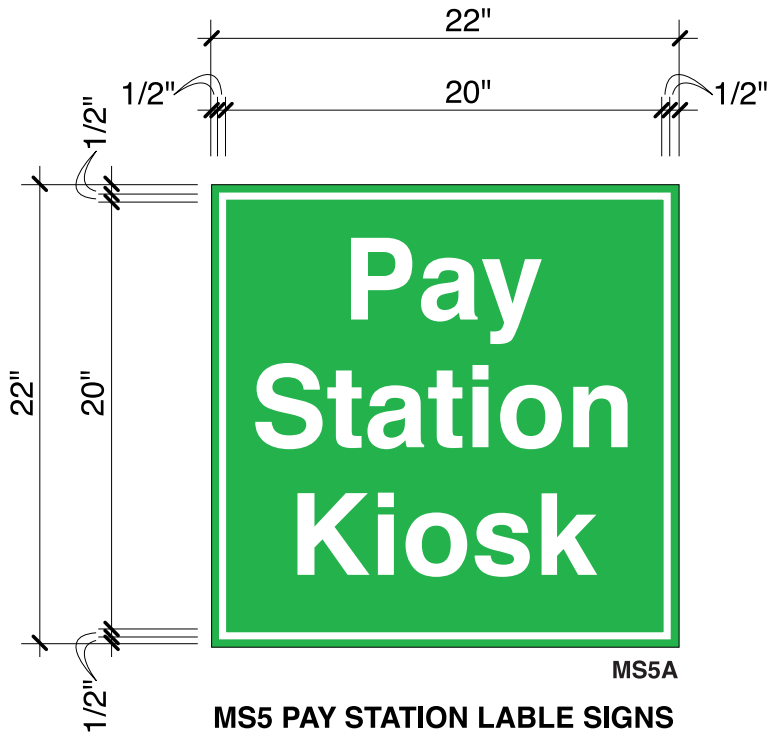

MS5A

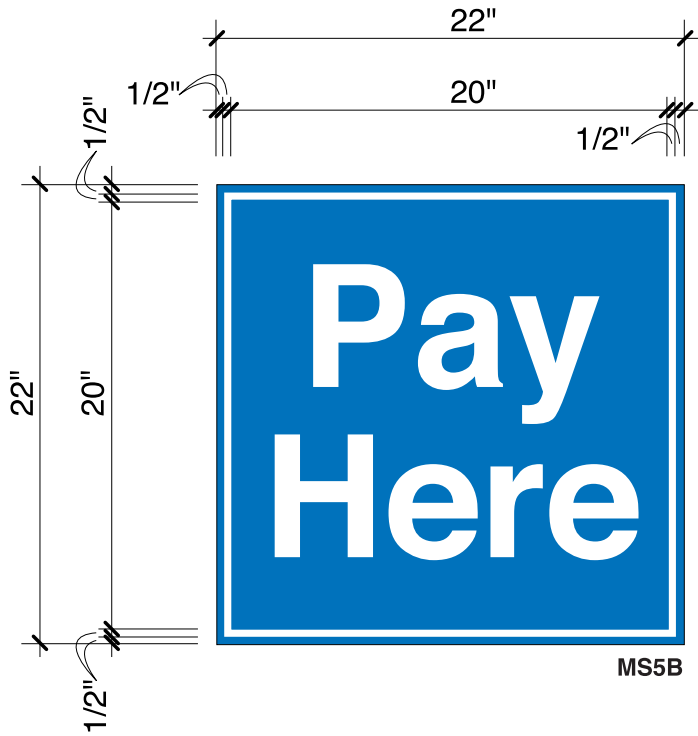

MS5B

**MS5 PAY STATION LABEL SIGNS LAYOUTS TYPICAL**

SCALE: 1-1/2"=1'-0"

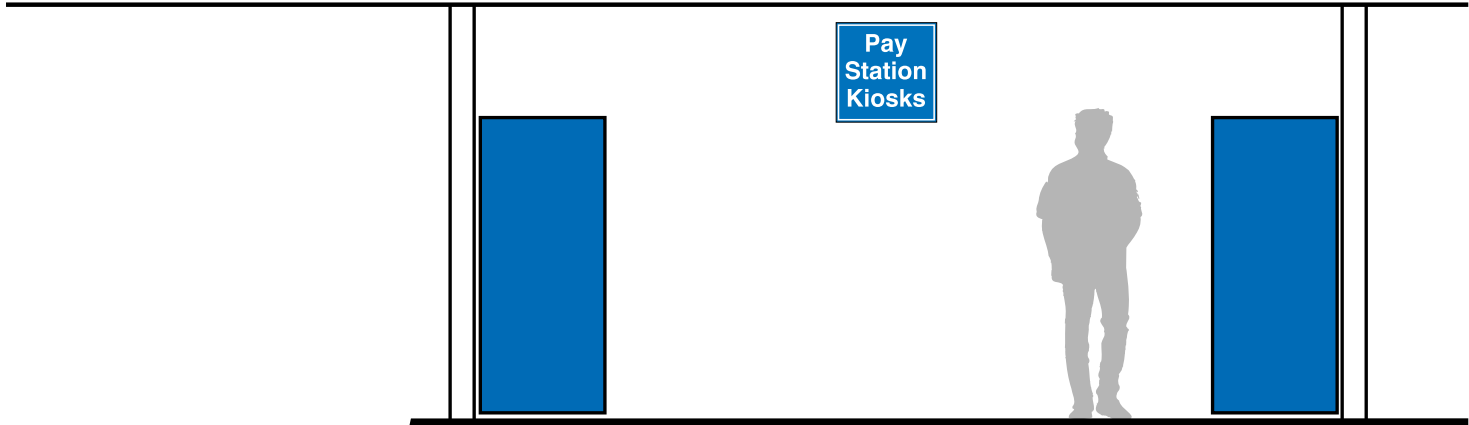

**MS5 PAY STATION LABELS - SIGN LOCATIONS**

MS5 Pay Station Labels sign panels are mounted to columns and walls to identify Pay Stations in a "Multi-Space" garage. Fabrication and layout are similar to Type PW7 signs.

Signs to be custom fabricated of .080 alum. with edges & corners filed & eased. No sharp edges or surfaces. All surfaces, front, back & sides to be primed & painted in colors to coincide with level designation standards, egg shell finish with acrylic polyurethane.

All lettering & borders to be white reflective film per MCDOT specifications. Typeface: Helvetica Bold upper/lower case as shown.

Locations will vary depending on location of Pay Stations. Verify as built conditions before programming sign messages.

Note: Face panels mount to concrete columns and / or steel columns or walls. All fasteners to be primed & "painted out" to match color of background.

All sign locations are to be confirmed with MCDOT at jobsite prior to drafting shop drawing submissions or installing signs.





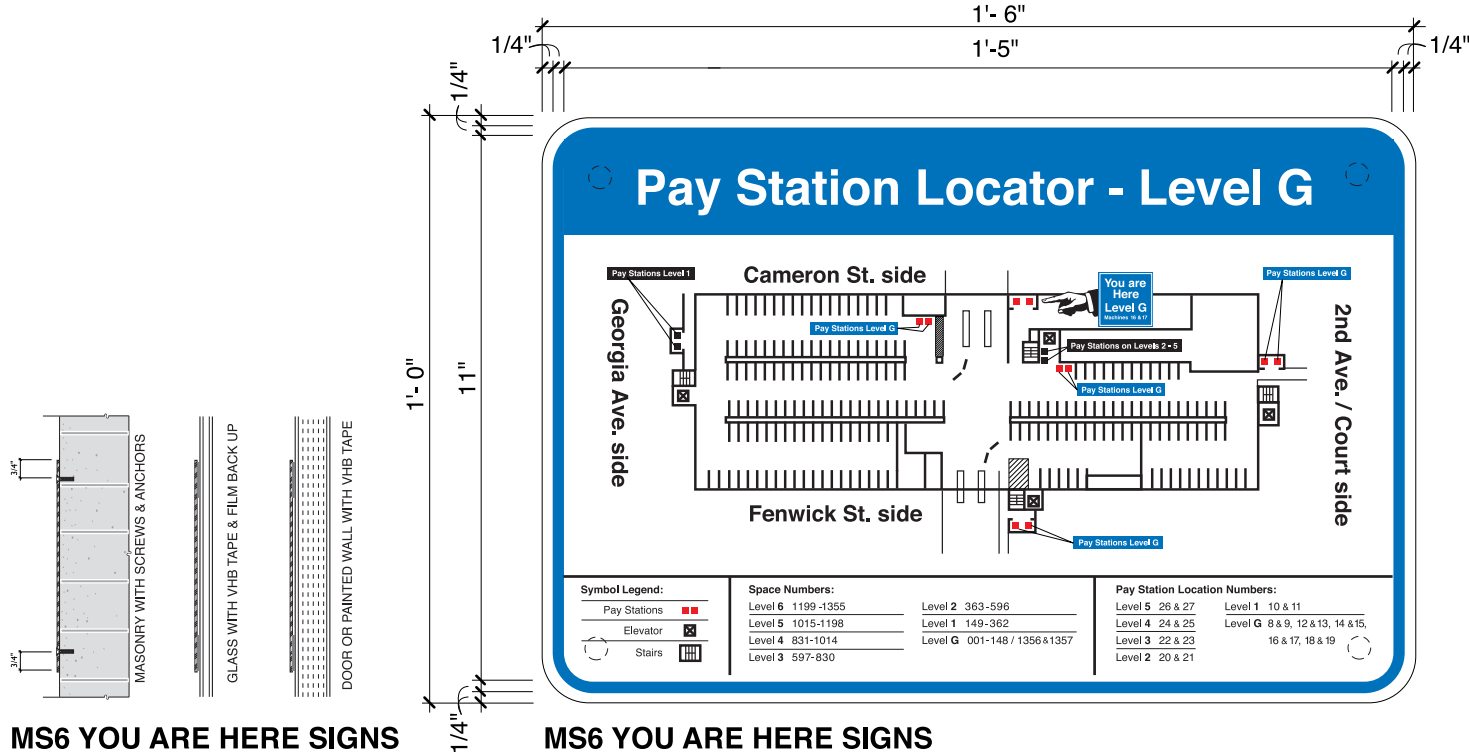

**MS6 YOU ARE HERE SIGNS MOUNTING TYPICAL**

Not to Scale

**MS6 YOU ARE HERE SIGNS LAYOUT TYPICAL**

SCALE: 1/4"=1"

MS6 "YOU ARE HERE" map signs to be 12"x 18" sign blanks of .080 aluminum primed & painted white with acrylic polyurethane on all surfaces. Edges to be eased by file to remove sharp. Corners to be rounded as shown.

1/4" Border line silkscreened in 300 Blue color. Map art, header and footer information to be output on digital print, white matte finish film adhesive backed and trimmed to fit as shown.

Panels mount to wall surfaces at Pay Station Kiosks to direct patrons waiting in line, to other locations. Panels mount with flat head screws into pre-drilled holes with anchors BEFORE digital print is applied to aluminum face. (Print covers screws)

Panels may be mounted to glass or wall surfaces with VHB tape and silicon adhesive. Signs mounted on glass to receive frosted film silhouette on back of glass to conceal mounting. Verify all exact sign locations with MCDOT prior to programming sign locations. All map art and messages are subject to MCDOT approval prior to printing.

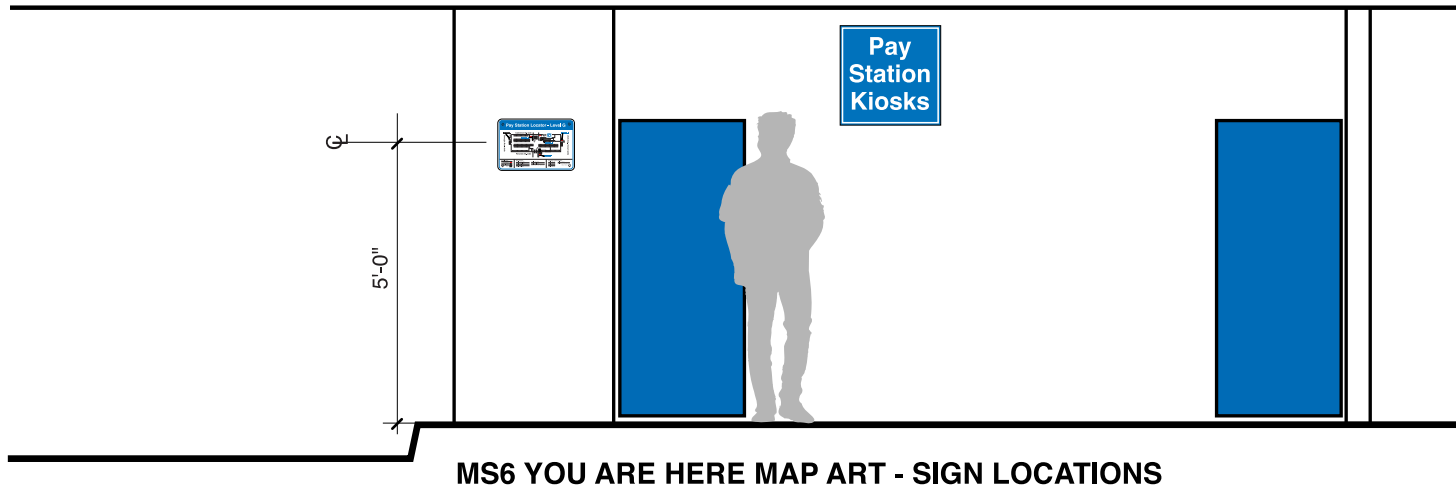

**MS6 YOU ARE HERE MAP ART - SIGN LOCATIONS**



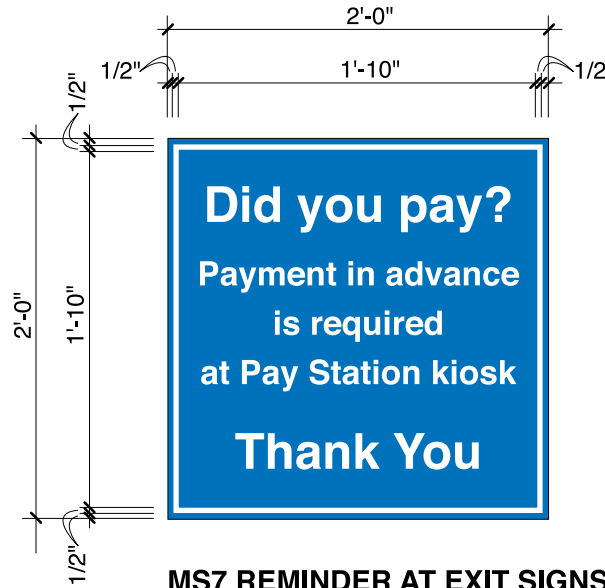

**MS7 REMINDER AT EXIT SIGNS  
LAYOUT TYPICAL**

SCALE: 1-1/2"=1'-0"

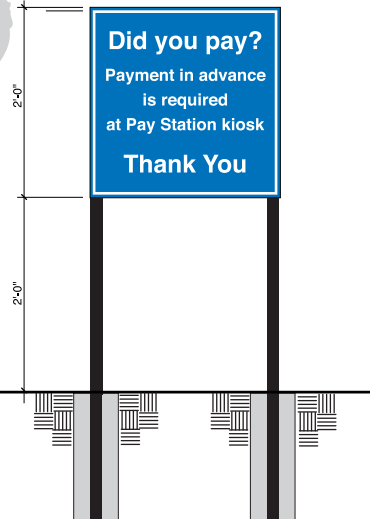

**MS7 REMINDER AT EXIT  
SIGN LOCATION**

SCALE: 3/4"=1'-0"

MS7 Reminder at Exit signs to be precision cut from .125 thk. aluminum with edges filed so no sharp surfaces. Signs may be wall mounted or freestanding.

Background primed & painted County standard Blue 300 or to match color designation of level where exit from garage occurs.

Border and lettering to be white reflective film sized as shown and centered on face panel.

Freestanding panels mounted to 1" sq. welded aluminum frame primed & painted black eggshell finish. Freestanding signs are installed direct burial into ground with 6" diameter CIP concrete footers minimum 18" depth.

Wall mounted panels use HILTI fasteners as required for secure attachment, minimum 4 mechanical fasteners (screws into anchors) at corners.

Verify all exact sign locations with MCDOT prior to programming sign locations. All map art and messages are subject to MCDOT



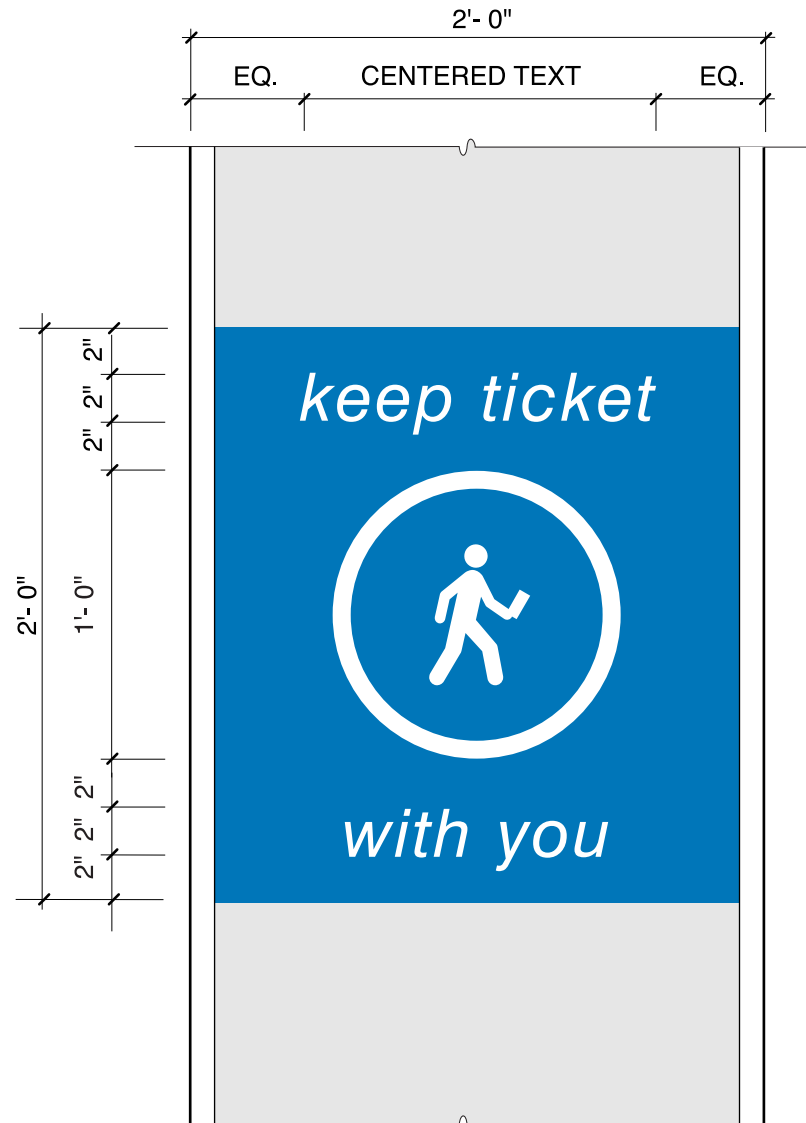

**PF1 REMINDER ON COLUMNS  
LAYOUT TYPICAL**

SCALE: 1-1/2"=1'-0"

Sign type PF1 coincides with painted level designation on columns within garages. Refer to sign type PW1 for coordination of layouts and orientation.

Contractor to prepare and prime surface of columns to be painted with bands, prior to application of background colors (per color coding of levels) and graphics.

Graphics to be hand-painted via 'frisket technique' in white from computer-generated template, precision cut and adhered to painted background surface as shown.

Row marking color bands are painted directly on primed concrete columns in colors to follow MCDOT level designation standards.

In all cases, paint face and sides of columns in 24" wide band as shown. At end column conditions paint all 4 sides and apply graphics to opposite facing surfaces.

Position of band is consistent 5'-0" to center, above finished floor. Bands on columns at ramps 'follow suit' but do not place graphics on four sides of column at ramp conditions.

Row marking stops at ramps in garages of more than one level. Ramps are not marked with level designation.

All applications of painted graphics receive top coat of clear anti-graffiti protection per MCDOT Sign Specifications. All coatings to be applied during warmer months to insure proper adhesion.



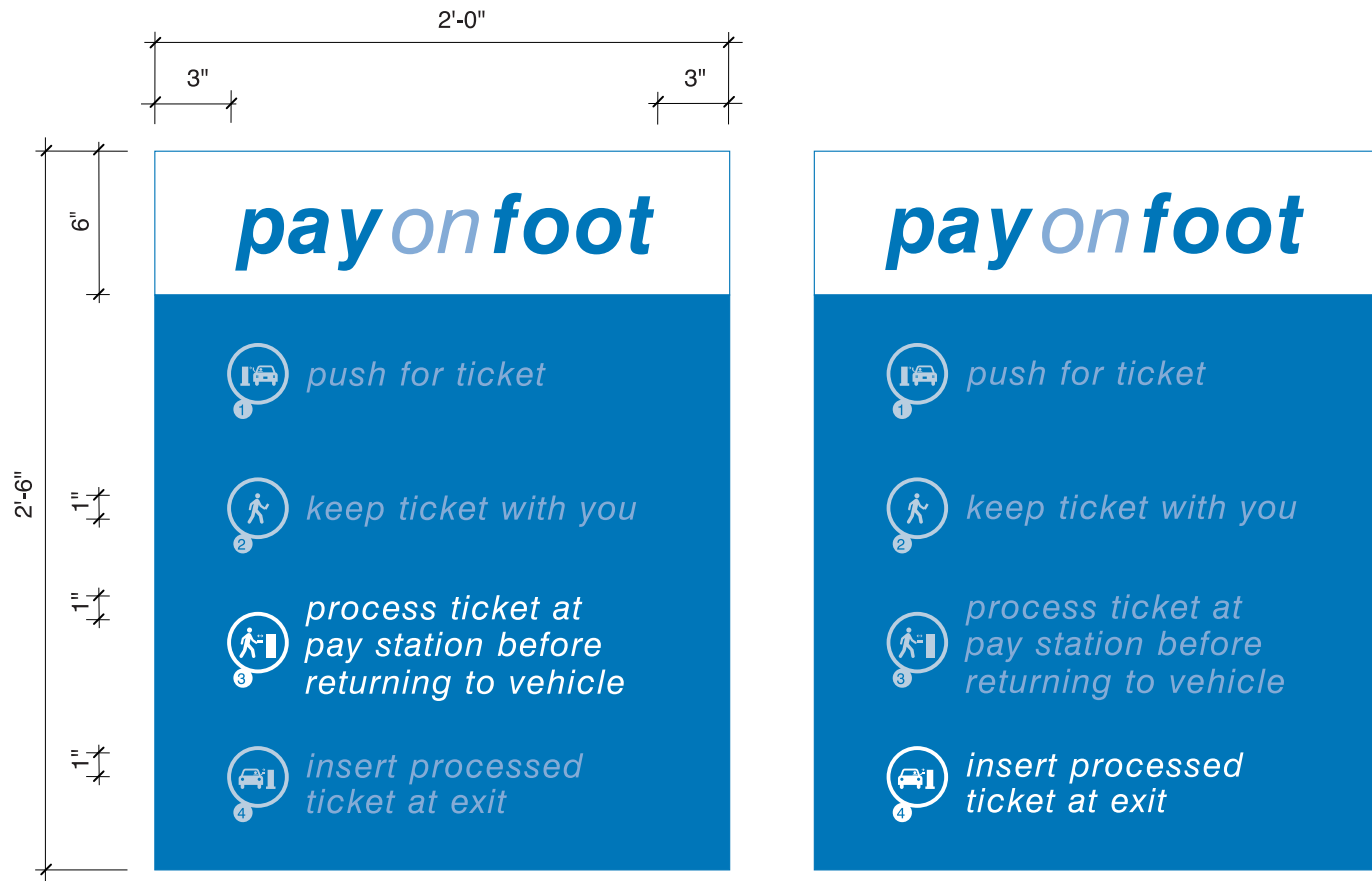

**PF2 INSTRUCTION PANEL  
LAYOUT TYPICAL OF PANELS "3" & "4" IN SERIES**

SCALE: 1-1/2"=1'-0"

Wall mounted pay on foot Reminder signs type PF2 (series 1-4) panels of .080 alum. with edges & corners filed & eased. No sharp surfaces. All surfaces, front, back & sides to be primed & painted egg shell finish w/ acrylic polyurethane to match level color designations with 6" header at top in white.

All artwork to be silkscreened in epoxy base ink typeface: Helvetica regular & bold italic, all lower case as shown. All artwork silkscreened at 50% of background color with the exception of "pay" and "foot" which are to match level color at 100%, and specified message which is to be white. See message schedule for details.

Sign contractor to submit shop drawings for confirmation of all details prior to mounting & attachment. drawings to include product names & numbers & all section/details necessary for record. Obtain MCDOT approval prior to fabrication.

Sign contractor to submit layout proofs (may be small scale) to MCDOT for confirmation of font, arrow art and dimensions, prior to affecting materials.

Note: copies of sign manual pages do not constitute submission proof.



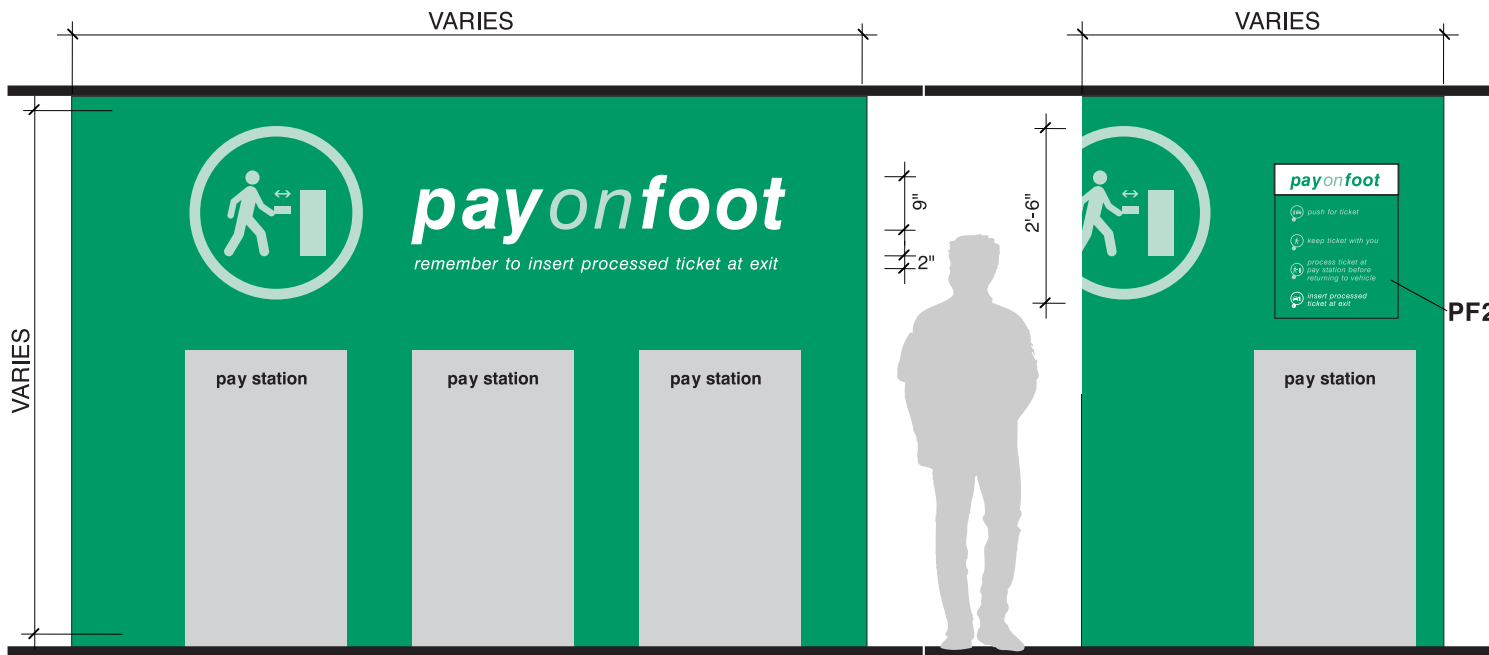

**PF3 SUPER-GRAPHIC MURAL LAYOUT TYPICAL**

Not to Scale



**PF3 SUPER-GRAPHIC MURAL SYMBOL DETAIL**

Not to Scale

Wall treatment PF3 at Pay Stations of garages are painted applications of super-graphics.

Contractor to prime and paint wall surfaces in level designation colors. In all cases wall is to be painted from ground to ceiling.

Graphics to be hand-painted via 'frisket technique' in white from computer-generated template, precision cut and adhered to painted background surface as shown. Graphics to be scaled to fit individual environments. All applications of painted graphics receive top coat of clear anti-graffiti protection per MCDOT Sign Specifications. All coatings to be applied during warmer months to insure proper adhesion.

Pictogram and "on" to be painted to match 50% of wall color. All other lettering to be white. In environment PF3, include sign type PF2. Locate at least 2" above the pay equipment or within 2'-0" of either side at least 5'-0" above finished floor to the center of the sign depending on space available at the locations.

Determine exact verbiage & quantities and express in Sign Message Schedule. Cross-reference to sign location plans for MCDOT.

Shop drawings for all signs to include product names & numbers & all materials & section/details necessary for County record.

Sign contractor to submit layout proofs (may be small scale) to MCDOT for confirmation of font, arrow art and dimensions, prior to affecting materials.

Note: Copies of sign manual pages do not constitute submission proof.



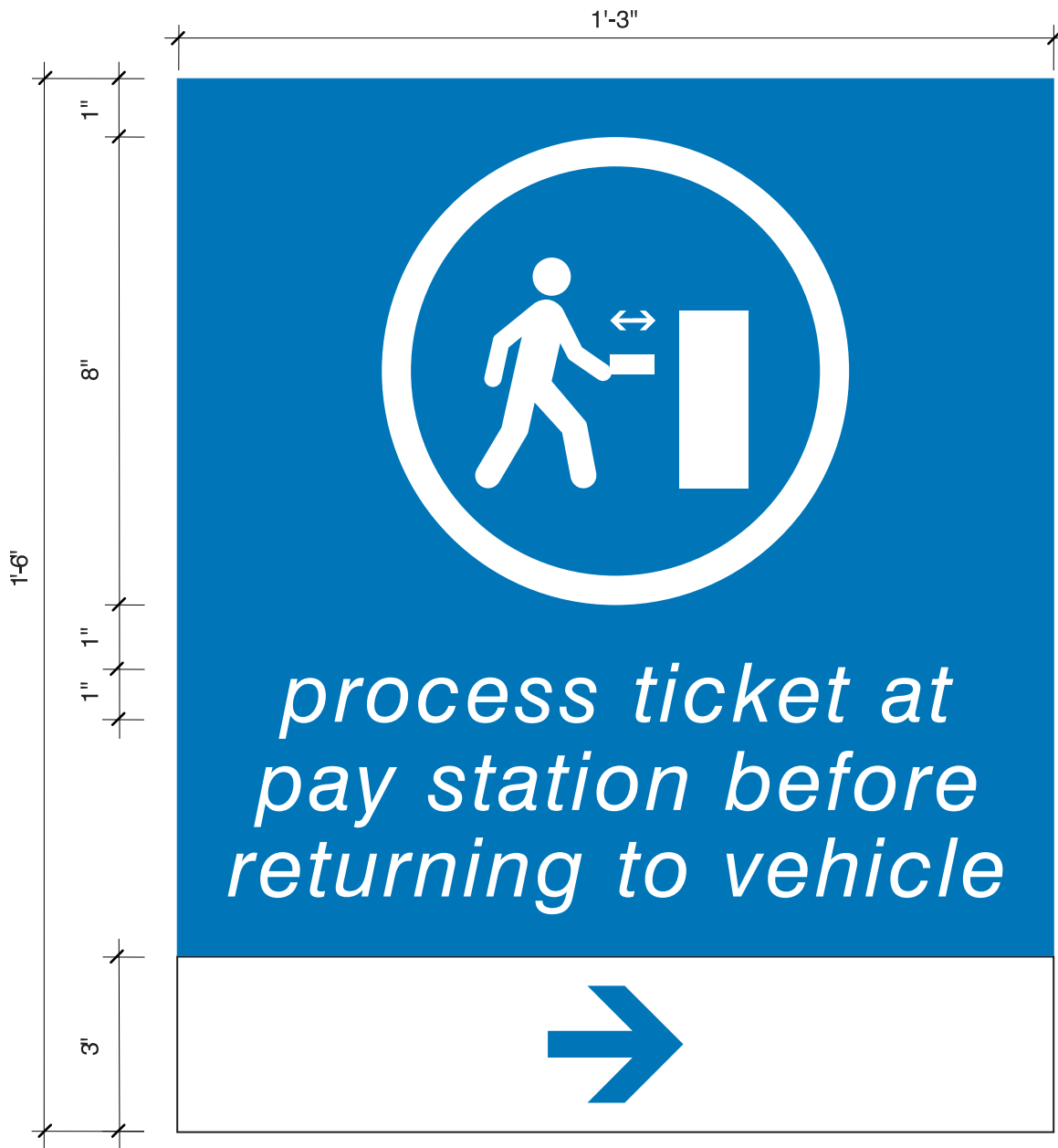

**PF4 DIRECTIONAL SIGN**

SCALE: 3" = 1'-0"

Wall mounted directional panels type PF4 of .080 alum. with edges & corners filed & eased. No sharp surfaces. All surfaces, front, back & sides to be primed & painted egg shell finish w/ acrylic polyurethane to match level color designations with 3" lower band area in white.

All artwork to be silkscreened in epoxy base ink. Typeface: Helvetica regular italic, all lower case as shown. All artwork and lettering to be silkscreened white.

Arrow in lower band to be silkscreened to match level designation color. Determine arrow directions and quantities and express in Sign Message Schedule. The cross-reference to sign location plan.

Shop drawings to include product names & numbers & all section/details necessary for County record. Get MCDOT approval prior to fabrication.

Sign contractor to submit layout proofs (may be small scale) to MCDOT for confirmation of font, arrow art and dimensions, prior to affecting materials.

Note: Copies of sign manual pages do not constitute submission proof.



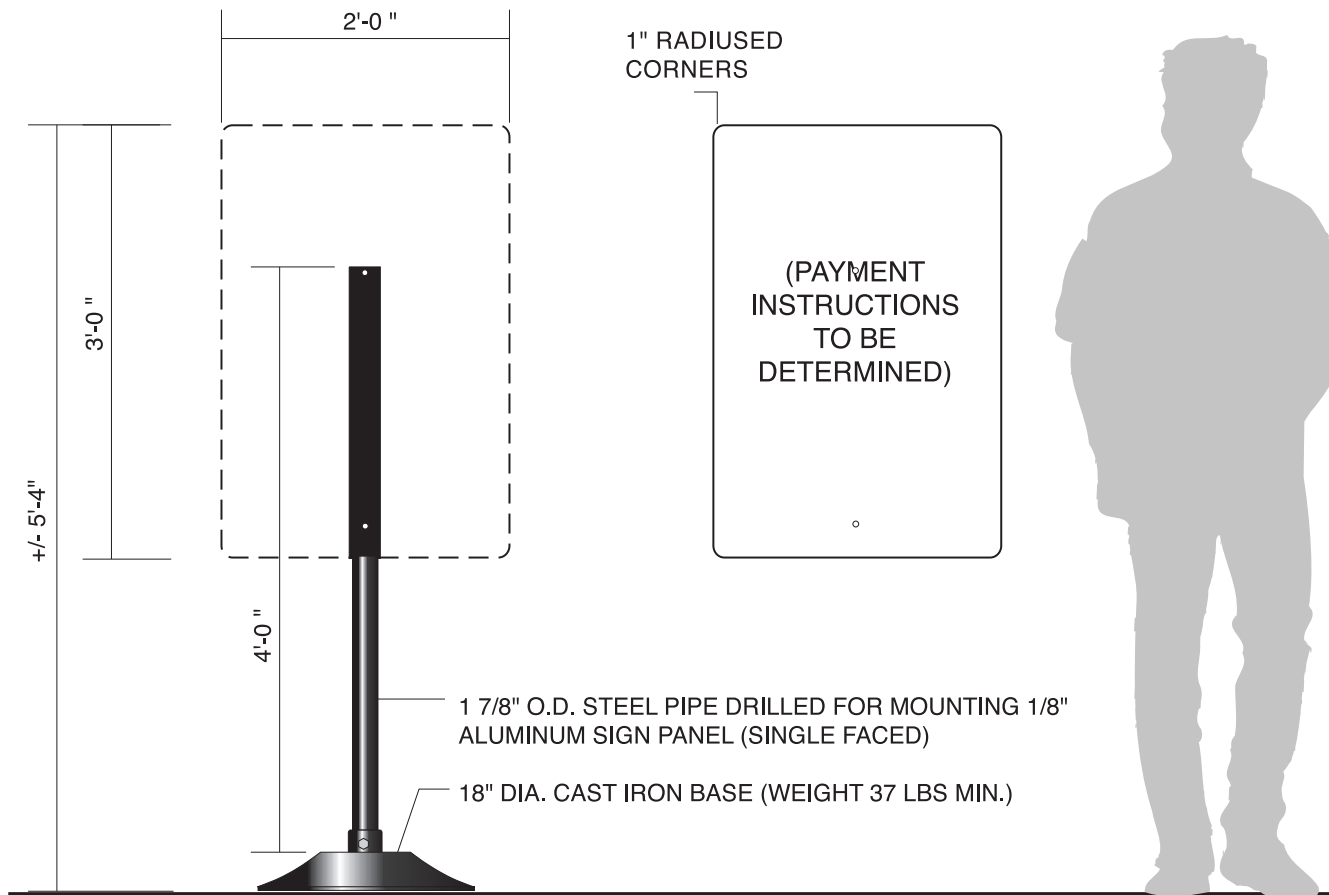

**PF5 PARKING SPACE MARKER**

SCALE: 3" = 1'-0"

Sign type PF5 is a pedestal base mounted sign with pay-on-foot information located near the ticket processing machines to explain their operation.

Sign panels are 1/8" aluminum, precision cut, with edges filed smooth, no sharp surfaces. Panels mount to 1 7/8" OD steel pipe with steel screws as shown.

Panel graphics will be silkscreened in 3 colors on a painted background, eggshell finish, in acrylic polyurethane, or applied as a digital print.

Back side of panel to be painted black, eggshell finish, with acrylic polyurethane to match other signs.

Suggested source for pedestal base: GP-5 18" cast iron base with 4 ft. pipe, FASTSIGNS (fastsigns.com) or similar.

Sign contractor to submit layout proofs to MCDOT once graphics have been determined, prior to affecting materials.

MCDOT will locate signs in the field as required.





**PF6A**

Overhead pay on foot reminder panels type PF6 of .080 alum. with edges & corners filed & eased. No sharp surfaces. Signs are similar on fabrication to DR12 sign types.



**PF6B**

All surfaces, front, back & sides to be primed & painted egg shell finish w/ acrylic polyurethane. Background colors coincide with level designation colors.

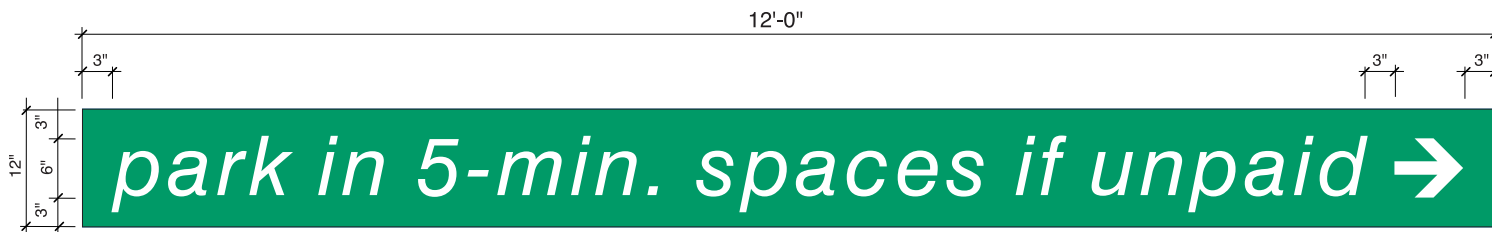

**PF6C**

Note: Face panels mount to concrete beams and welded steel frames at double-sided conditions. Counter-sunk fasteners to be primed & "painted out" to match background.

All lettering & arrows to be white reflective film. Typeface: Helvetica regular italic, all lower case as shown.

**PF6 OVERHEAD INSTRUCTIONS**

SCALE: 3/4" = 1'-0"

Sign contractor to submit shop drawings with engineer's seal for confirmation of all details prior to mounting & attachment. Drawings to include product names & numbers of all materials & all sections/details necessary for County record. Obtain MCDOT approval prior to fabrication.

Confirm all overhead sign locations with MCDOT at job site prior to installation.





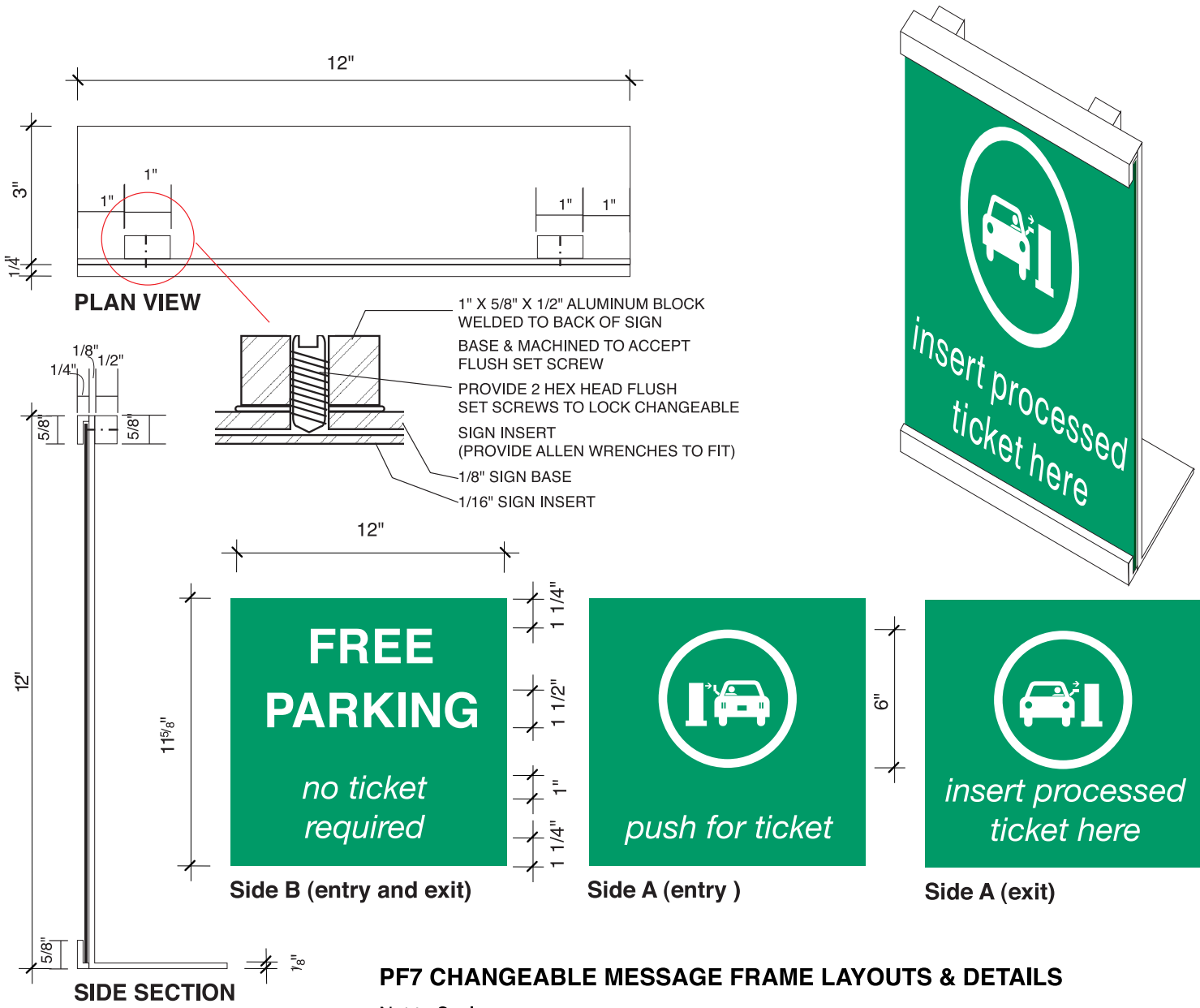

Wall mounted or freestanding pay on foot entry/exit panels type PF7 of .125 alum. (bases) & .080 (faces) with edges & corners filed & eased. No sharp surfaces.

All surfaces, front, back & sides to be primed & painted egg shell finish w/ acrylic polyurethane to match level color designations. All artwork to be silkscreened in white - epoxy base ink typeface: helvetica regular italic, all lower case as shown.

Determine exact verbiage & quantities and express in Sign Message Schedule. Provide sign location plans for orientation.

Purpose of PF7 is to provide changeable message capability at garage entries and exits. Signs may be mounted atop ticket spitter machine gates.

Sign contractor to submit shop drawings for confirmation of all details prior to mounting & attachment. Drawings to include product names & numbers of all materials & all sections/details necessary for County record. Obtain MCDOT approval prior to fabrication.



**PF8 PARKING DESIGNATION - LAYOUT**

SCALE: 1/4" = 1"

PF8 space designation panels of .080 aluminum, precision cut, with edges filed smooth - no sharp surfaces. Panels mount directly to walls and columns.

Panels to be primed & painted to match level color. Coating to be acrylic polyurethane to be eggshell finish. All rear surfaces of the sign assembly are to be painted black, eggshell finish.

Lettering and border to be silkscreened white. "pay" and "foot" lettering to be level color. "on" to be 50% of level color.

Sign panels to be installed at proper height on wall or post, at consistent position for uniform appearance.

PF8 panels may be bolted to 2" sq. extruded aluminum posts, primed and painted black) at the direction of MCDOT. Note: Use touch-up paint to cover mounting hardware to match background.

PF8 space designation panels may, in some instances, mount to wire fence with pop rivets through aluminum clips. Wires may follow grade change on garage ramps but signs are to be installed level, and at consistent height. Minimum 3 fasteners per panel.





**RG1 HC PARKING STANDARD - LAYOUT**

SCALE: 3" = 1"

RG1 Handicapped parking signs for longer messages - to be precision cut from .125 thk. aluminum with edges filed and corners rounded as shown. No sharp surfaces.

All metal surfaces to be primed & painted white with acrylic polyurethane.

Background layer of white reflective film by 3M® ScotchLite™ or equal.

Border and lettering to be silkscreened green, symbol silkscreened DOT 280-76 blue as shown.

In most cases, panels are wall mounted to replace existing signs as MCDOT directs.

Minimum 4 mechanical fasteners (screws into anchors) at corners in positions as indicated, not in the border.

Note: digital file for layout is available from MCDOT for matching art exactly.

Note: RG1 units may mount on County standard pole with concrete footers if required. 2" Square aluminum post primed & painted black with 12" x 18" concrete foundation below grade.





**OTHER LAYOUTS**

SCALE: 1-1/2" = 1'-0"

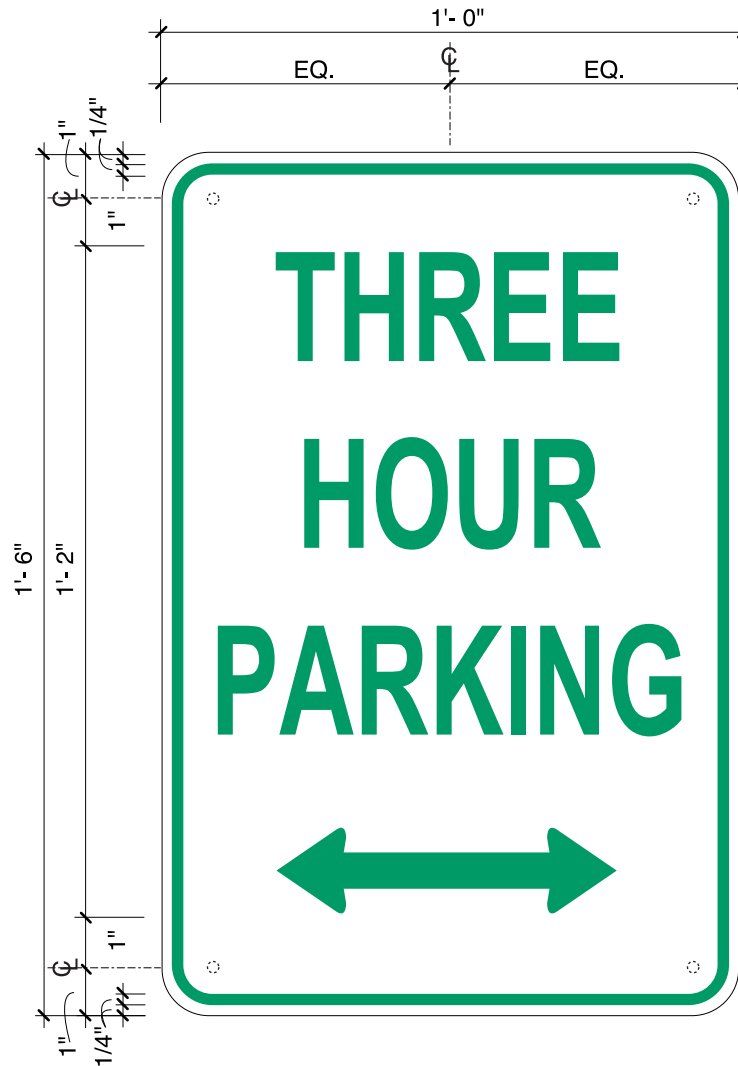

**RG2 PARKING TIME RESTRICTION - LAYOUT**

SCALE: 3" = 1"

RG2 Parking space time designation panels of .080 aluminum, precision cut, with edges filed smooth, no sharp surfaces. Panels mount directly to concrete walls & columns as required and as directed by County at install.

2 holes centered top & bottom for mounting to columns with "band-it" or on walls with screws and anchors.

All surfaces of aluminum to be primed & painted white with acrylic polyurethane, eggshell finish.

Face of signs is clad in white reflective film. Border and lettering and arrows to be green reflective film as shown.

"STRICTLY ENFORCED", when necessary, to be red reflective film centered at bottom. Provide layouts with quantities to MCDOT for proofing prior to fabrication and installation.

In most cases, panels are wall mounted to replace existing signs as MCDOT directs. Minimum 4 mechanical fasteners (screws into anchors) at corners in positions as indicated, not in the border.

Note: digital file for layout is available from MCDOT for matching art exactly.

Note: RG1 units may mount on County standard pole with concrete footers if required. 2" Square aluminum post primed & painted black with 12" x 18" concrete foundation below grade.





**OTHER LAYOUTS**

SCALE: 1-1/2" = 1'-0"



**RG3 PERMIT PARKING SIGN - LAYOUT**

SCALE: 3" = 1"

RG3 Permit Parking space designation panels of .080 aluminum, precision cut, with edges filed smooth, no sharp surfaces. Panels mount directly to concrete walls & columns as required and as directed by County at install.

2 holes centered top & bottom for mounting to columns with "band-it" or on walls with screws and anchors.

All surfaces of aluminum to be primed & painted white with acrylic polyurethane, eggshell finish.

Face of signs is clad in white reflective film. Border and lettering and arrows to be black reflective film as shown.

"STRICTLY ENFORCED", when necessary, to be red reflective film centered at bottom. Provide layouts with quantities to MCDOT for proofing prior to fabrication and installation.

In most cases, panels are wall mounted to replace existing signs as MCDOT directs. Minimum 4 mechanical fasteners (screws into anchors) at corners in positions as indicated, not in the border.

Note: digital file for layout is available from MCDOT for matching art exactly.

Note: RG1 units may mount on County standard pole with concrete footers if required. 2" Square aluminum post primed & painted black with 12" x 18" concrete foundation below grade.





**OTHER LAYOUTS**

SCALE: 1-1/2" = 1'-0"

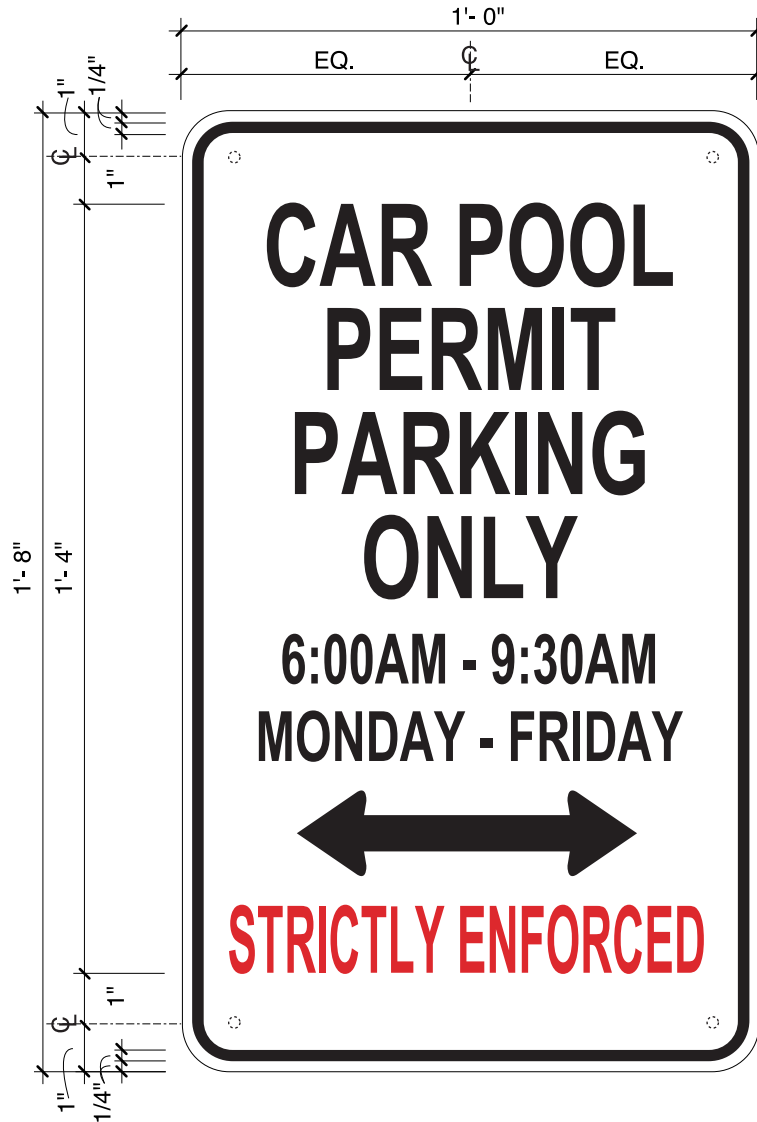

**RG4 CARPOOL SIGN - LAYOUT**

SCALE: 3" = 1"

RG4 Carpool space designation panels of .080 aluminum, precision cut, with edges filed smooth, no sharp surfaces. Panels mount directly to concrete walls & columns as required and as directed by County at install.

2 holes centered top & bottom for mounting to columns with "band-it" or on walls with screws and anchors.

All surfaces of aluminum to be primed & painted white with acrylic polyurethane, eggshell finish.

Face of signs is clad in white reflective film. Border and lettering and arrows to be black reflective film as shown.

"STRICTLY ENFORCED", to be red reflective film centered at bottom. Provide layouts with quantities to MCDOT for proofing prior to fabrication and installation.

In most cases, panels are wall mounted to replace existing signs as MCDOT directs. Minimum 4 mechanical fasteners (screws into anchors) at corners in positions as indicated, not in the border.

Note: digital file for layout is available from MCDOT for matching art exactly.

Note: RG1 units may mount on County standard pole with concrete footers if required. 2" Square aluminum post primed & painted black with 12" x 18" concrete foundation below grade.





**OTHER LAYOUTS**

SCALE: 1-1/2" = 1'-0"



**RG5 BIKE SPACE SIGN - LAYOUT**

SCALE: 3" = 1"

RG5 Bike or Motorcycle space designation panels of .080 aluminum, precision cut, with edges filed smooth, no sharp surfaces. Panels mount directly to concrete walls & columns as required and as directed by County at install.

2 holes centered top & bottom for mounting to columns with "band-it" or on walls with screws and anchors.

All surfaces of aluminum to be primed & painted white with acrylic polyurethane, eggshell finish.

Face of signs is clad in white reflective film. Border and lettering and arrows to be green reflective film as shown.

"NO MOTORIZED VEHICLES", to be red reflective film centered at bottom. Provide layouts with quantities to MCDOT for proofing prior to fabrication and installation.

In most cases, panels are wall mounted to replace existing signs as MCDOT directs. Minimum 4 mechanical fasteners (screws into anchors) at corners in positions as indicated, not in the border.

Note: digital file for layout is available from MCDOT for matching art exactly.

Note: RG1 units may mount on County standard pole with concrete footers if required. 2" Square aluminum post primed & painted black with 12" x 18" concrete foundation below grade.





**OTHER LAYOUTS**

SCALE: 1-1/2" = 1'-0"



**RG6 NO PARKING ANY TIME - LAYOUT**

SCALE: 3" = 1"

RG6 NO PARKING sign panels of .080 aluminum, precision cut, with edges filed smooth, no sharp surfaces. Panels mount directly to concrete walls & columns as required and as directed by County at install.

2 holes centered top & bottom for mounting to columns with "band-it" or on walls with screws and anchors.

All surfaces of aluminum to be primed & painted white with acrylic polyurethane, eggshell finish.

Face of signs is clad in white reflective film. Border and lettering and arrows to be red reflective film as shown.

Provide layouts with quantities to MCDOT for proofing prior to fabrication and installation.

In most cases, panels are wall mounted to replace existing signs as MCDOT directs. Minimum 4 mechanical fasteners (screws into anchors) at corners in positions as indicated, not in the border. Note: May be 2 fasteners through BandIt® on steel columns (4 preferred).

Note: digital file for layout is available from MCDOT for matching art exactly.

Note: RG1 units may mount on County standard pole with concrete footers if required. 2" Square aluminum post primed & painted black with 12" x 18" concrete foundation below grade.





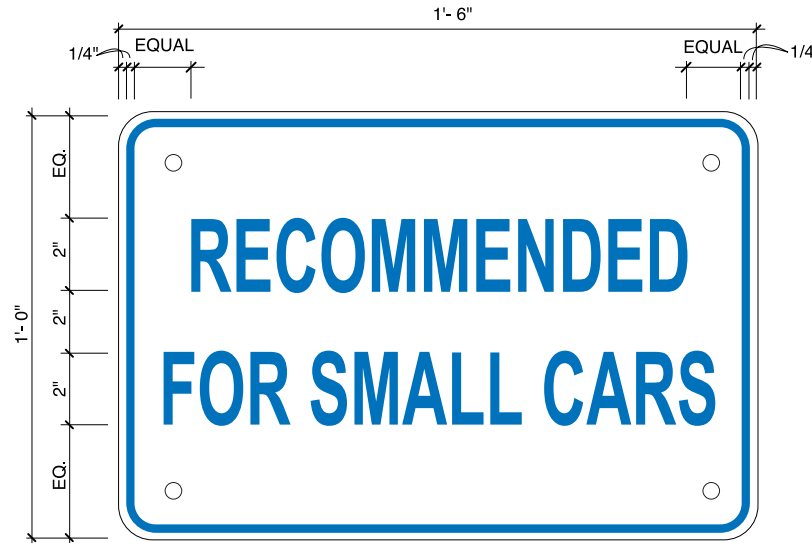

**RG7 SMALL CAR SPACE SIGN - LAYOUT**

SCALE: 3" = 1"

RG7 SMALL CAR sign panels of .080 aluminum, precision cut, with edges filed smooth, no sharp surfaces. Panels mount directly to concrete walls & columns as required and as directed by County at install.

2 holes centered top & bottom for mounting to columns with "band-it" or on walls with screws and anchors.

All surfaces of aluminum to be primed & painted white with acrylic polyurethane, eggshell finish.

Face of signs is clad in white reflective film. Border and lettering and arrows to be blue reflective film as shown.

Provide layouts with quantities to MCDOT for proofing prior to fabrication and installation.

In most cases, panels are wall mounted to replace existing signs as MCDOT directs. Minimum 4 mechanical fasteners (screws into expansion sleeve anchors) at corners in positions as indicated, not in the border.

Note: digital file for layout is available from MCDOT for matching art exactly.

Note: RG1 units may mount on County standard pole with concrete footers if required. 2" Square aluminum post primed & painted black with 12" x 18" concrete foundation below grade.





**OTHER LAYOUTS**

SCALE: 1-1/2" = 1'-0"



**RG8 USE CROSSWALK SIGN - LAYOUT**

SCALE: 3" = 1"

RG8 Use Crosswalk sign panels of .080 aluminum, precision cut, with edges filed smooth, no sharp surfaces. Panels mount directly to concrete walls & columns as required and as directed by County at install.

2 holes centered top & bottom for mounting to columns with "band-it" or 4 holes at corners for mounting on walls with screws and anchors.

All surfaces of aluminum to be primed & painted white with acrylic polyurethane, eggshell finish.

Face of signs is clad in yellow reflective film 3M™ 3721 or equal. Border and lettering and arrows to be black opaque film as shown.

Provide layouts with quantities to MCDOT for proofing prior to fabrication and installation.

In most cases, panels are wall mounted to replace existing signs as MCDOT directs. Minimum 4 mechanical fasteners (screws into expansion sleeve anchors) at corners in positions as indicated, not in the border.

Note: digital file for layout is available from MCDOT for matching art exactly.

Note: RG1 units may mount on County standard pole with concrete footers if required. 2" Square aluminum post primed & painted black with 12" x 18" concrete foundation below grade.



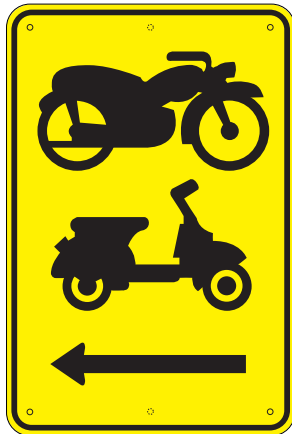
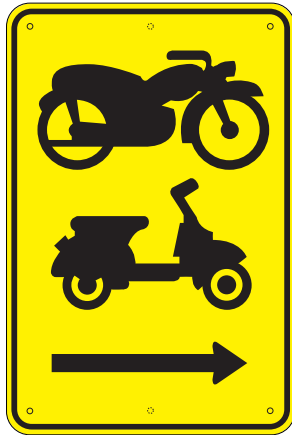

**OTHER LAYOUTS**

SCALE: 1-1/2" = 1'-0"

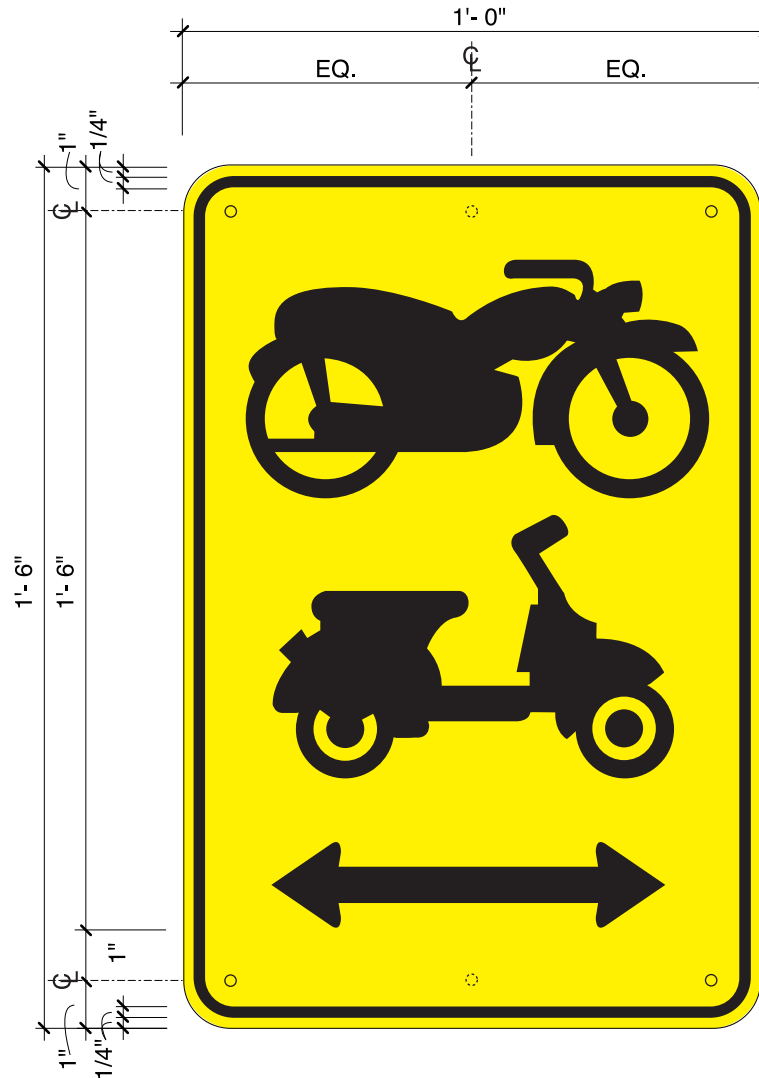

**RG9 2-WHEEL PARKING ONLY - LAYOUT**

SCALE: 3" = 1"

RG9 2-Wheel Parking Only sign panels of .080 aluminum, precision cut, with edges filed smooth, no sharp surfaces. Panels mount directly to concrete walls & columns as required and as directed by County at install.

2 holes centered top & bottom for mounting to columns with "band-it" or 4 holes when mounted on walls with screws and anchors.

All surfaces of aluminum to be primed & painted white with acrylic polyurethane, eggshell finish.

Face of signs is clad in reflective film: Engineer Grade Yellow 3271.

Border and symbols and arrows to be black opaque glossy film cut by computer and positioned as shown.

In most cases, panels are wall mounted or to replace existing signs as MCDOT directs. Minimum 4 mechanical fasteners (screws into anchors) at corners in positions as indicated, not in the border.

Note: digital file for layout is available from MCDOT for matching art exactly.

Note: RG9 units may mount on County standard pole with concrete footers if required. 2" Square aluminum post primed & painted black with 12" x 18" concrete foundation below grade.





**RG10 SCOOTER PARKING ONLY - LAYOUT**

SCALE: 1/2" = 1"

RG10 Scooter Parking Only sign decals of reflective film: 3M™ Engineer Grade Yellow 3271.

Lettering and symbol to be black opaque glossy film cut by computer and positioned as shown.

Decals to be applied directly to painted bike racks in consistent position as MCDOT directs.

Note: digital file for layout is available from MCDOT for matching art exactly.

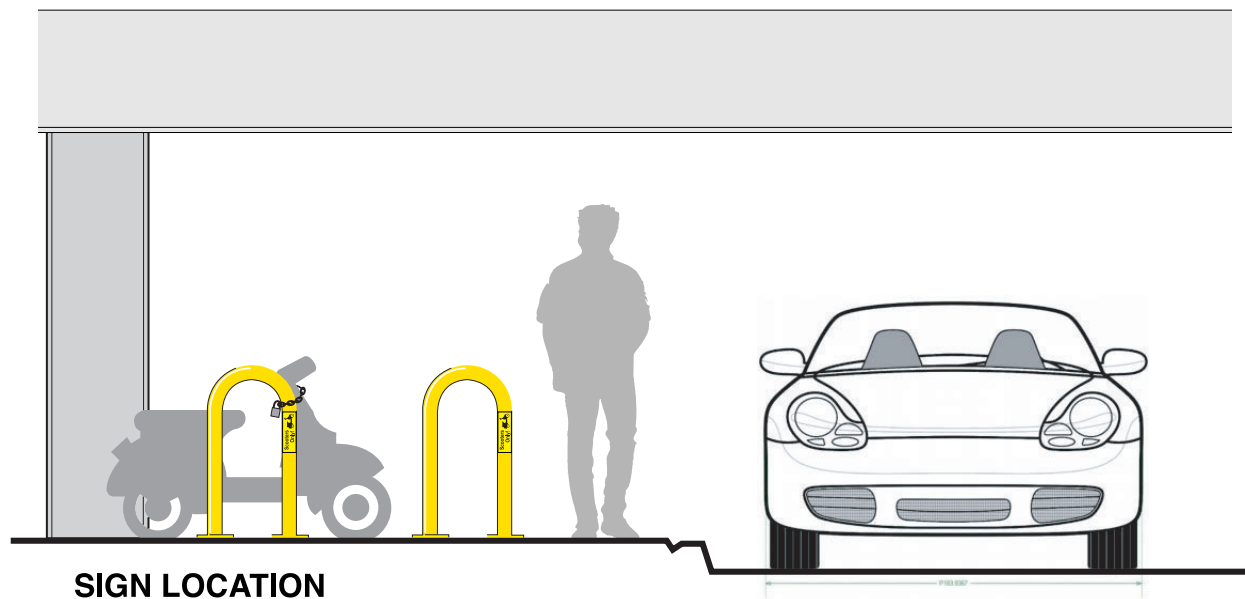

**SIGN LOCATION**

SCALE: 3/8" = 1'-0"

