



MONTGOMERY COUNTY, MARYLAND
DEPARTMENT OF TRANSPORTATION
DEPARTMENT OF PERMITTING SERVICES

SIGHT DISTANCE EVALUATION

Plan Number:

Project Name:

ENGINEER/ SURVEYOR CERTIFICATE

I hereby certify that this information is accurate and was collected in accordance with these guidelines.

Signature: [Handwritten Signature]

26328

PLS/PE MD Reg. No

3/25/2024

Date

Montgomery County Review:

Approved

Disapproved:

By:

Date:

Table with columns: Erskine Avenue @ Randolph Road, CLASS (Town Center Boulevard), SPEED (40 MPH), APPROACHING MOTOR VEHICLES (VERTICAL L/R, HORIZONTAL), APPROACHING BIKEWAYS (HORIZONTAL), APPROACHING SIDEWALK (HORIZONTAL), COMMENTS (Right-in/Right-out only, therefore only need sight distance to the Left)

FORM APPROVED 11.8.2023 Date, Chief, Division of Transportation Engineering, Chief, Land Development, REVISED

Montgomery County Department of Transportation, Sight Distance Review Form



**MONTGOMERY COUNTY, MARYLAND**  
**DEPARTMENT OF TRANSPORTATION**  
**DEPARTMENT OF PERMITTING SERVICES**

**SIGHT DISTANCE REQUIREMENTS ATTACHMENT**

**GENERAL INFORMATION**

All sight distance targets are to be based on Intersection Sight Distance as defined in the current version of AASHTO's *A Policy on Geometric Design of Highways and Streets* (aka the "Green Book").

All sight distance measurements must account for anticipated obstructions such as the presence of full-grown foliage, street furniture, and vehicles occupying designated curbside areas (e.g. parked vehicles).

Designs are required to ensure that all approaches to conflict points provide adequate sight distance, even when approaches are not explicitly evaluated.

**SPEEDS**

The Posted Speed will generally be used for sight distance analyses where it may be presumed that it is reflective of operating speeds. MCDOT may instead direct that an applicant perform a speed study, in which case the higher of the posted speed or the speed study's 85<sup>th</sup> Percentile operating speed is to be used for determining sight distance needs.

If no Posted Speed is provided: perform a 24-hour speed study to identify the 85<sup>th</sup> Percentile Operating Speed (unless otherwise directed by MCDOT) for use in determining sight distance adequacy.

Where specific issues at a location limit the meaningfulness of a Speed Study (such as short blocks of free-flow travel), then with MCDOT approval the Target Speed for that road classification may be used in lieu of a speed study.

Along Neighborhood Streets and Neighborhood Yield Streets with no Posted Speed, and where speeds of 25 MPH or less may be reasonably expected, then with MCDOT approval the Target Speed for these streets may be used.

Use a 15 MPH design speed for Bikeways.

**VERTICAL SIGHT DISTANCE**

Unless otherwise directed by MCDOT or MCDPS: Vertical Sight Distance only needs to be evaluated for approaches toward motor vehicle travelways; not Bikeways or Sidewalks.

**HORIZONTAL SIGHT DISTANCE**

Horizontal Sight Distance evaluations are required for approaches to motor vehicle travelways and Bikeways.

Where visual inspection of plans raises concern, Horizontal Sight Distance evaluations may optionally be required by MCDOT or DPS for any other approaches to conflict points.

Drawings on the following pages provide guidance on how to measure horizontal sight distance.

Where Bikeways are present: measurements must consider individually the approach to the Bikeway as well as the approach to the Motor Vehicle travelway.



**MONTGOMERY COUNTY, MARYLAND**  
 DEPARTMENT OF TRANSPORTATION  
 DEPARTMENT OF PERMITTING SERVICES

**2-LANE UNDIVIDED ROADWAY**

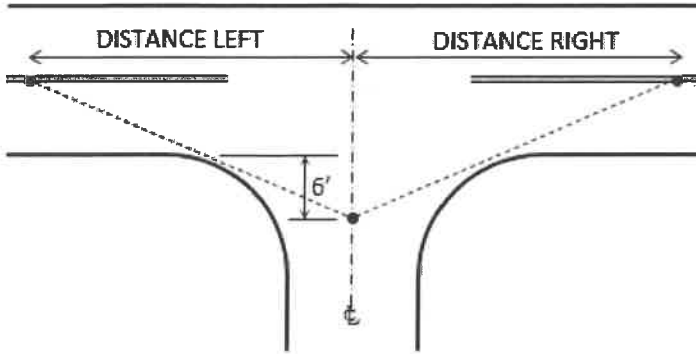

**MULTI-LANE UNDIVIDED ROADWAY**

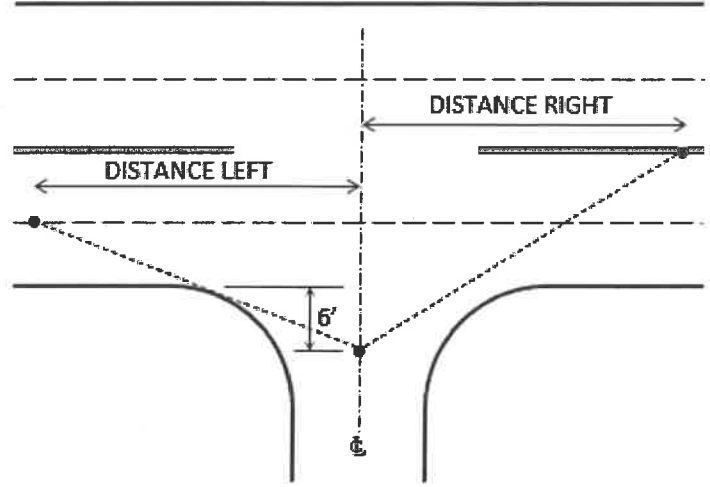

**ROADWAY WITH CURBSIDE LANE**

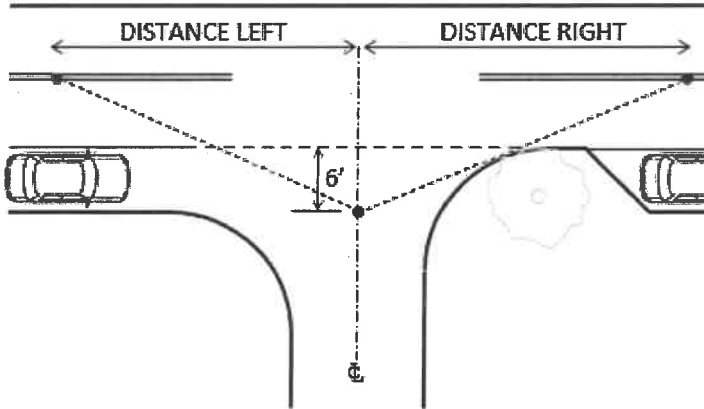

**MULTI-LANE DIVIDED ROADWAY**

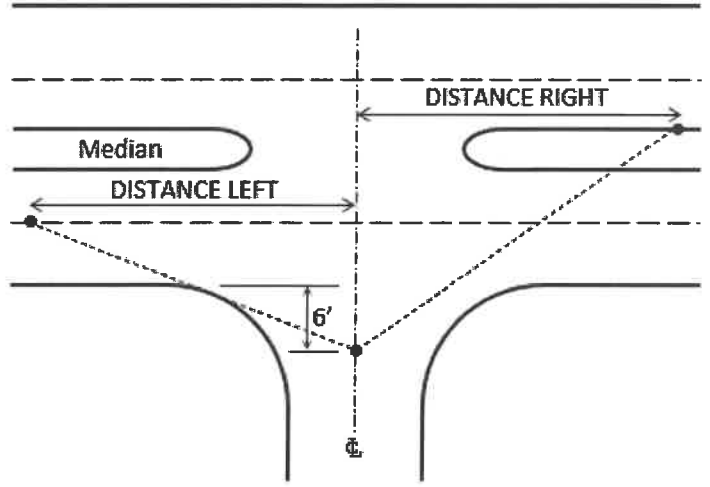

**MOTOR VEHICLE MEASUREMENT W/ CONVENTIONAL BIKE LANE**

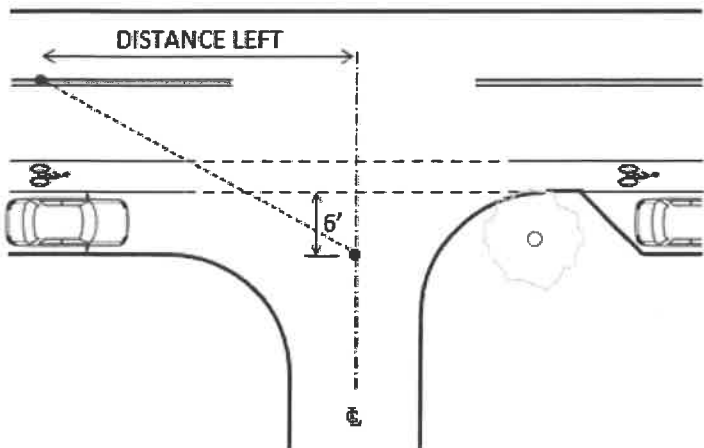

**MEASURING SIGHT DISTANCE TOWARD  
 CONFLICTING MOTOR VEHICLES**

Sight distance for crossing motor vehicle travelways is measured:

- From an eye height of 3.5' at a point on the centerline of the approaching travelway 6' back from the face of curb or edge of the nearest Travel Lane,
- To a point 3.5' above the road surface along the intersecting road.
- Use the speed of the conflicting travelway.

White Lane Lines      Double Yellow  $\text{C}$



**MONTGOMERY COUNTY, MARYLAND**  
 DEPARTMENT OF TRANSPORTATION  
 DEPARTMENT OF PERMITTING SERVICES

**CONVENTIONAL BIKE LANE**

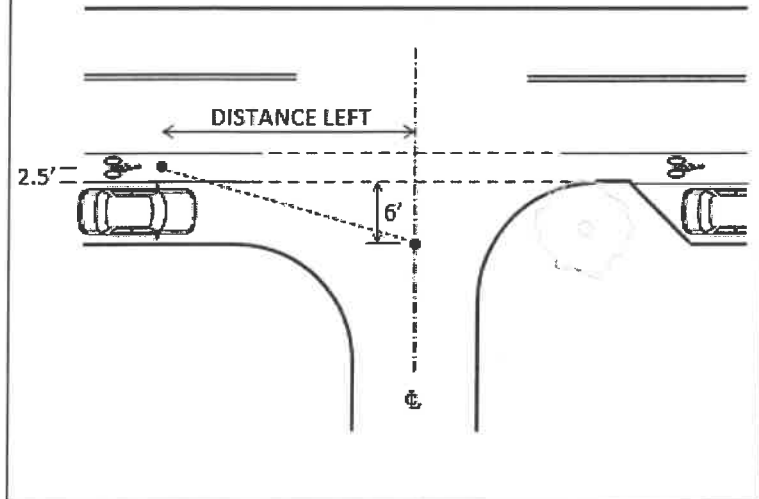

**TWO-WAY SEPARATED BIKE LANE**

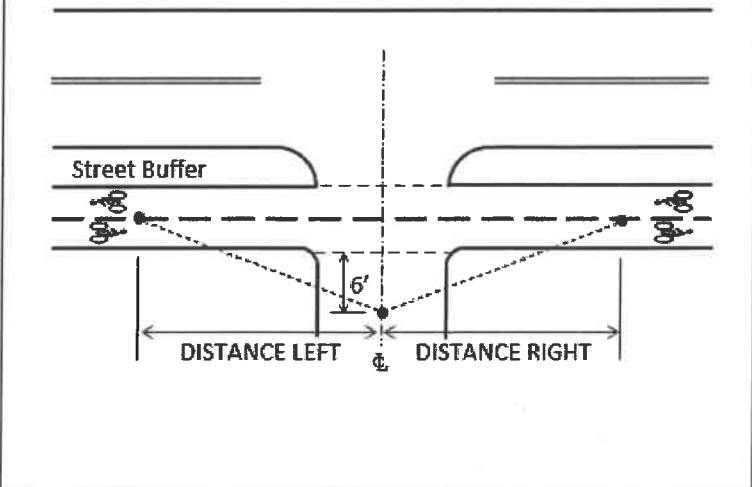

**ONE-WAY SEPARATED BIKE LANE**

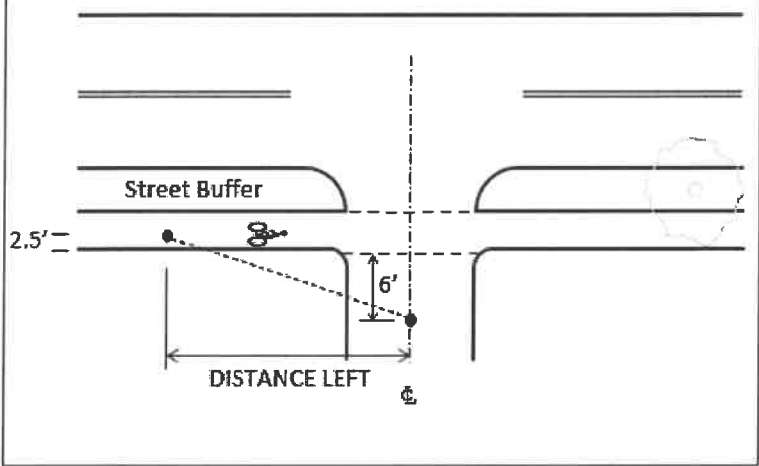

**SIDEPATH**

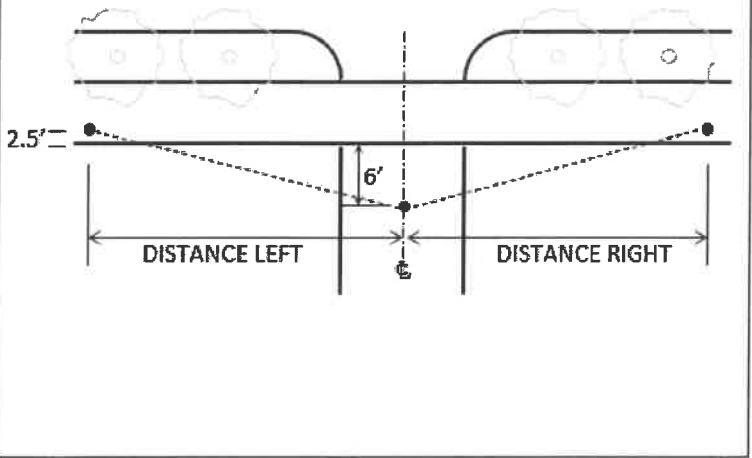

**MEASURING SIGHT DISTANCE TOWARD CONFLICTING BICYCLES**

Sight distance for crossing Bikeways is measured:

- From an eye height of 3.5' at a point on the centerline of the approaching travelway 6' back from the edge of the nearest Bikeway,
- To a point 3.5' above the intersecting Bikeway either along the centerline of bidirectional Bikeways or 2.5' horizontally beyond the nearest edge of a single-direction Bikeway.
- Use 15 MPH for the speed of Bikeways.
- Sight distance measurements must account individually for the Bikeway (as shown above) as well as the motor vehicle (as shown on the previous page).

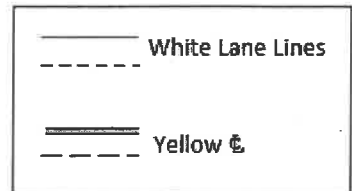



# MONTGOMERY COUNTY, MARYLAND

DEPARTMENT OF TRANSPORTATION

DEPARTMENT OF PERMITTING SERVICES

## SIDEWALK

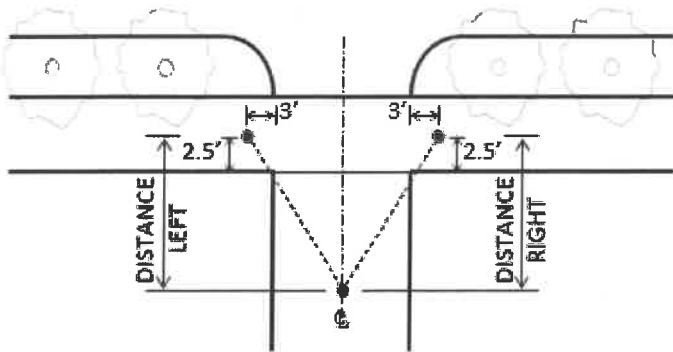

## MEASURING SIGHT DISTANCE FOR APPROACHING SIDEWALKS

Sight distance for crossing Sidewalks is not typically required to be calculated unless otherwise directed by MCDOT for cases where it appears the proposed conditions may be limited (such as at parking garage exits).

Sight distance for crossing Sidewalks is measured from a point on the crossed Sidewalk instead of the approaching road / alley / driveway, using the speed of the approaching road / alley / driveway:

- From an eye height of 3.5' at a point 2.5' from the edge of the sidewalk nearest to the site, 3' away from the extension of the approaching road / alley / driveway's edge of pavement,
- To a point 3.5' above the approaching road / alley / driveway along the centerline of the nearest approaching lane.
- Sidewalks are typically located in the Clear Zone, but the point measured from may include the Frontage Zone &/or Maintenance Buffer if these areas are readily traversable as like the Clear Zone.

MCDOT may direct that garage exits, alleys, or driveways with a distinctly low-speed approach may use a design speed of 5 or 10 MPH.

## MEASURING SIGHT DISTANCE FOR APPROACHING PEDESTRIANS CROSSING BIKEWAYS

Sight distance measurements for a Sidewalk or Sidepath crossing a Bikeway are not typically required to be calculated unless otherwise directed by MCDOT for cases where it appears that proposed conditions may have limited sight distance.

This sight distance is measured:

- From an eye height of 3.5' at a point on the centerline of the approaching Sidewalk / Sidepath 3' back from the edge of the nearest Bikeway,
- To a point 3.5' above the intersecting Bikeway, 2.5' horizontally beyond the nearest edge of the Bikeway.
- Use 15 MPH for the speed of Bikeways.

## SIDEWALKS AT CONVENTIONAL BIKE LANE

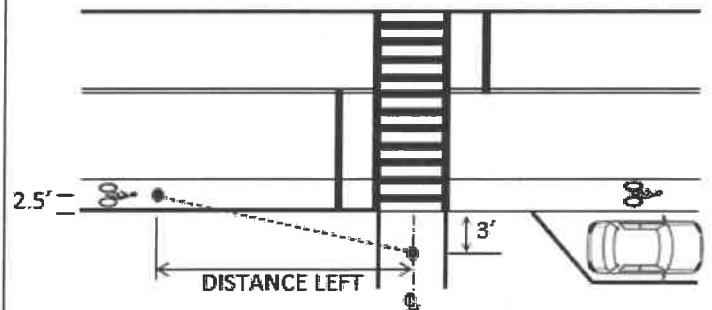

## SIDEWALK AT ONE-WAY SEPARATED BIKE LANE

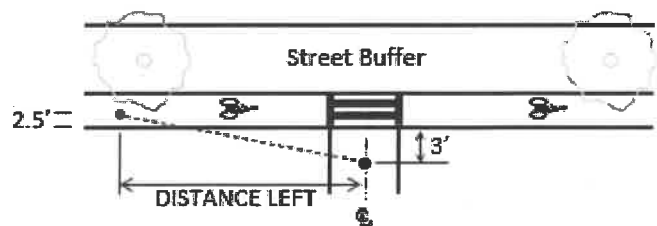

## SIDEWALK AT TWO-WAY SEPARATED BIKE LANE

