

TYPICAL SECTIONS

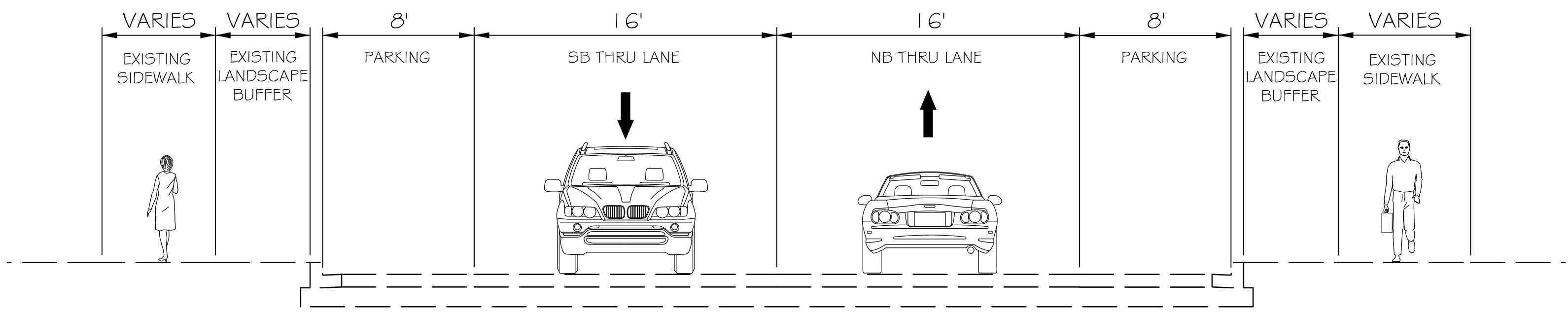

WINDHAM LANE TO PRITCHARD ROAD
EXISTING TYPICAL SECTION

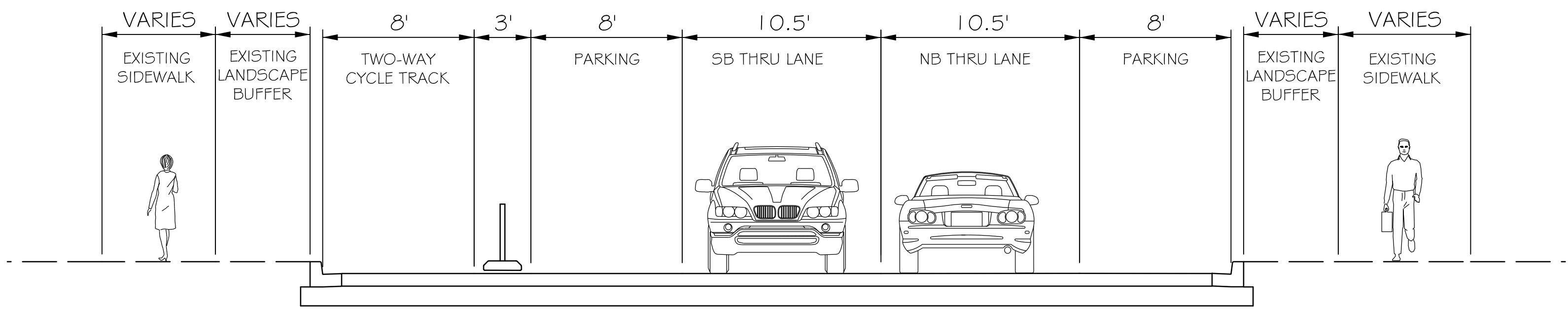

WINDHAM LANE TO PRITCHARD ROAD
PROPOSED TYPICAL SECTION

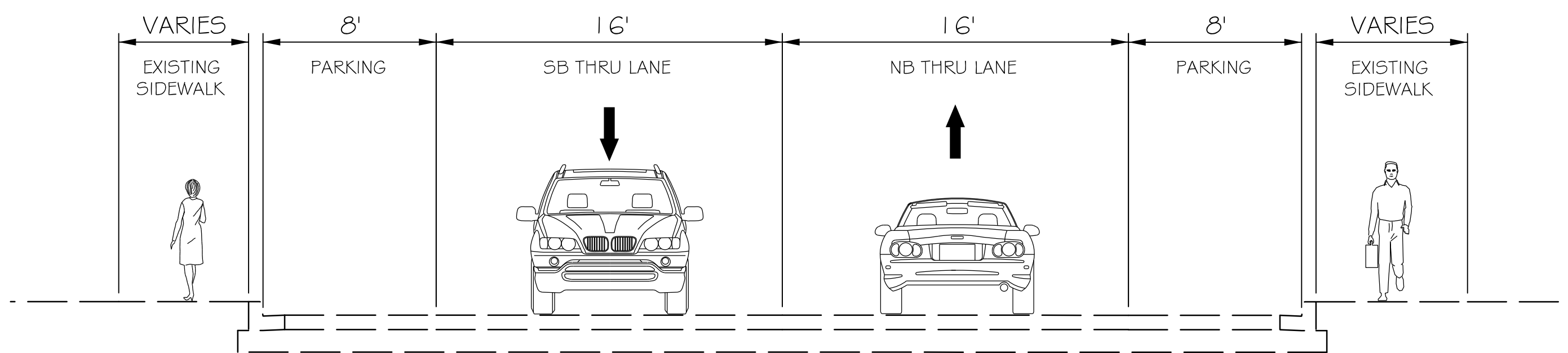

REEDIE DRIVE TO SOUTH OF UNIVERSITY BOULEVARD (MD 193)
EXISTING TYPICAL SECTION

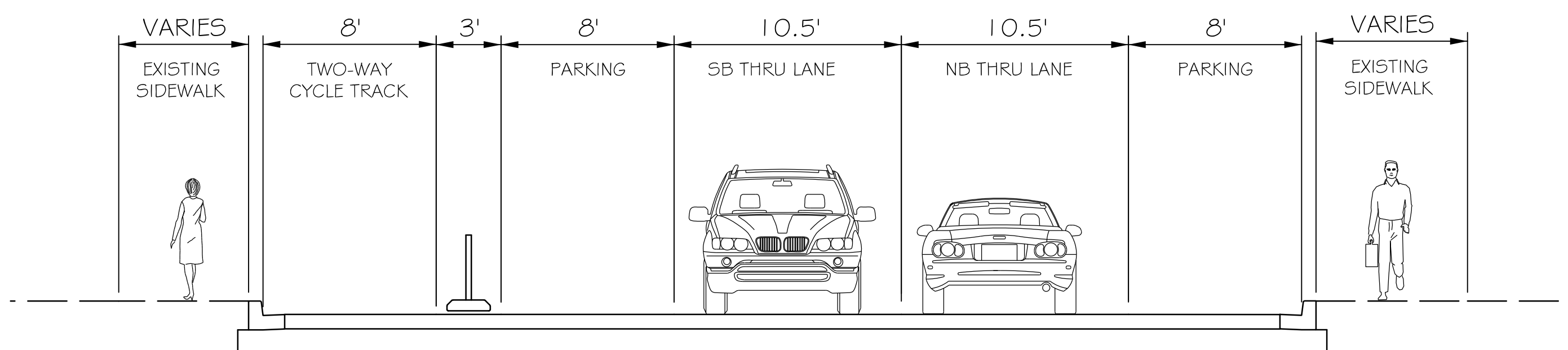

REEDIE DRIVE TO SOUTH OF UNIVERSITY BOULEVARD (MD 193)
PROPOSED TYPICAL SECTION

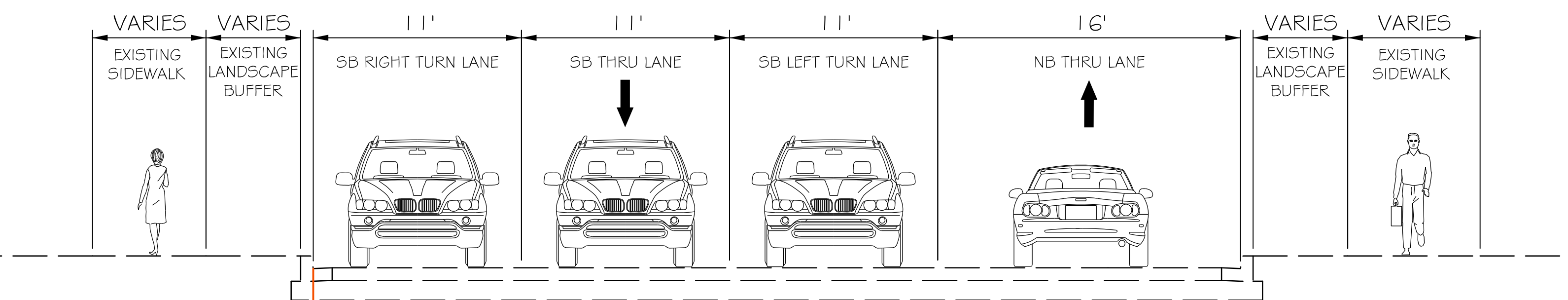

UNIVERSITY BOULEVARD (MD 193)
EXISTING TYPICAL SECTION

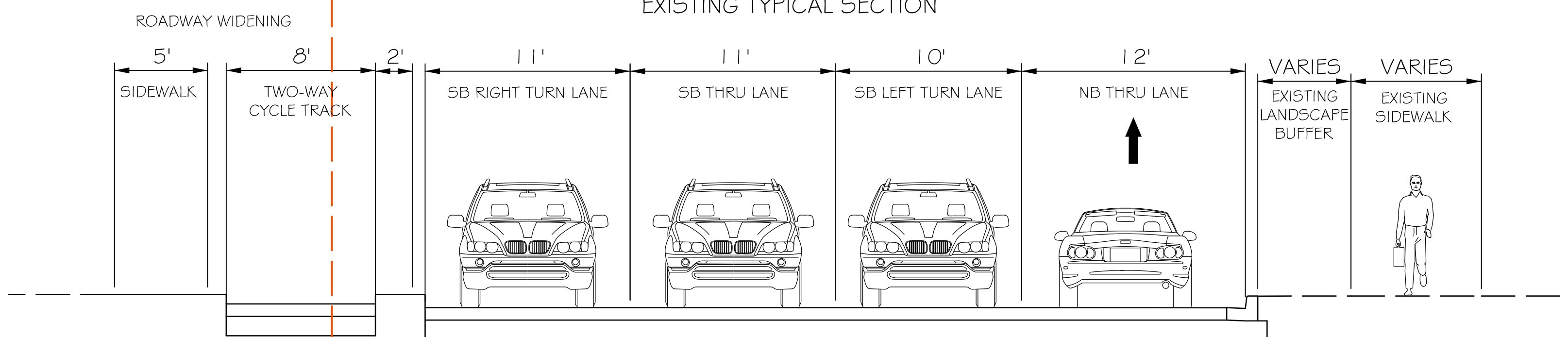

UNIVERSITY BOULEVARD (MD 193)
PROPOSED TYPICAL SECTION

NOTE: TYPICAL SECTIONS FOR PRITCHARD ROAD TO REEDIE DRIVE
OPTIONS ARE LOCATED ON AMHERST AVENUE BIKEWAY -
FROM PRITCHARD ROAD TO REEDIE DRIVE | WHEATON CBD.

AMHERST AVENUE BIKEWAY - FROM WINDHAM LANE TO ARCOLA AVENUE | WHEATON CBD

TYPICAL SECTIONS

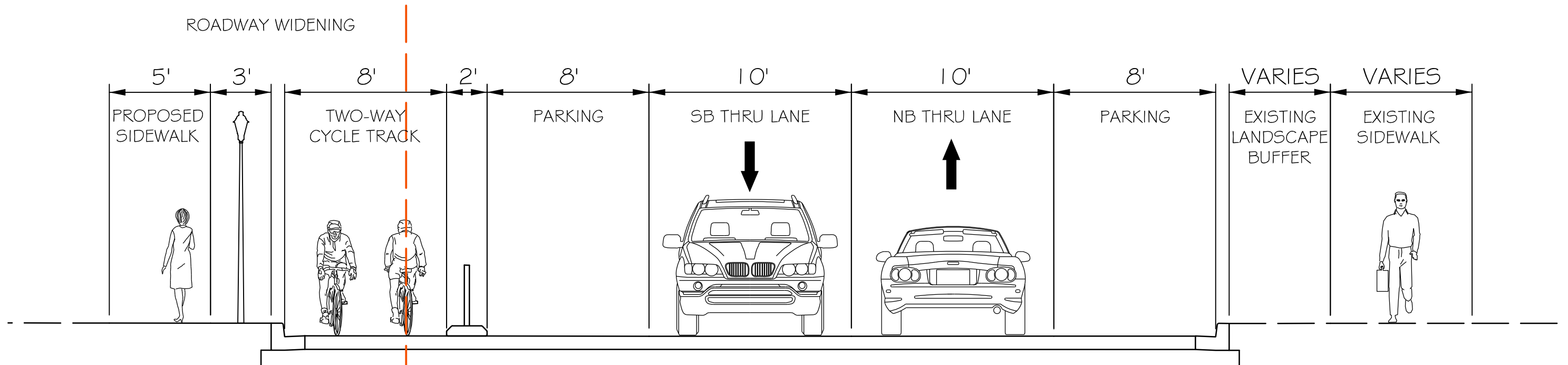
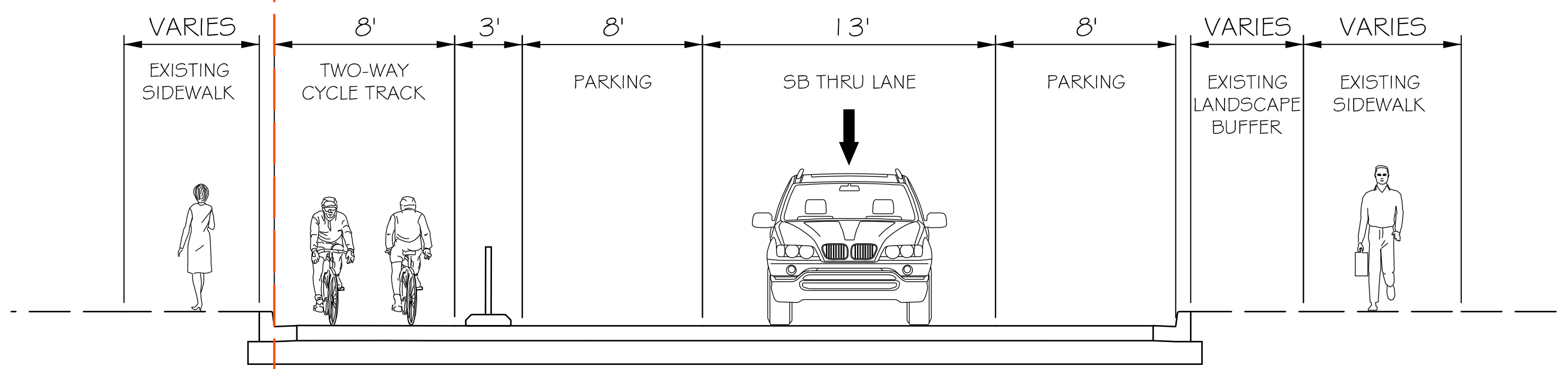
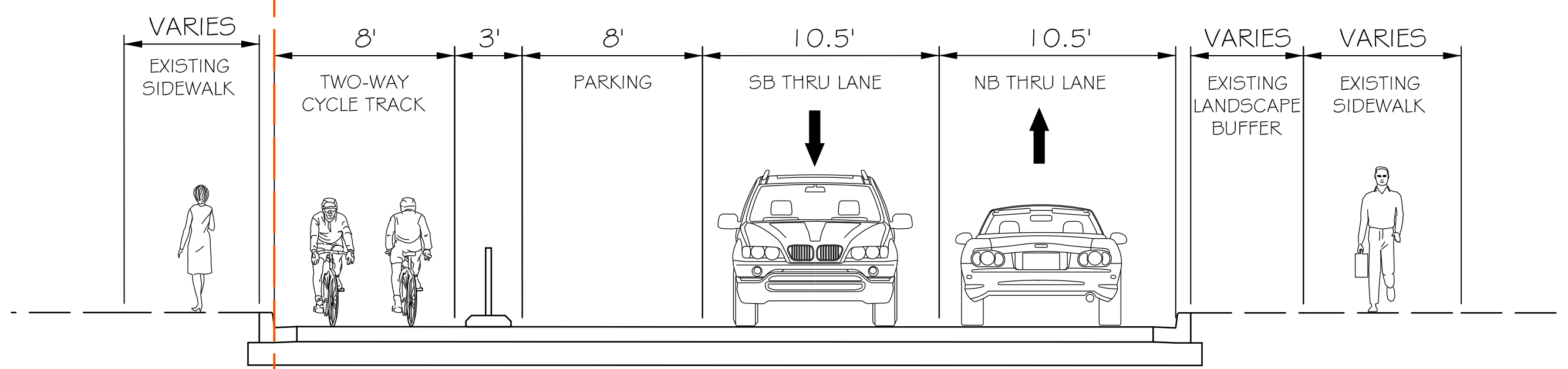
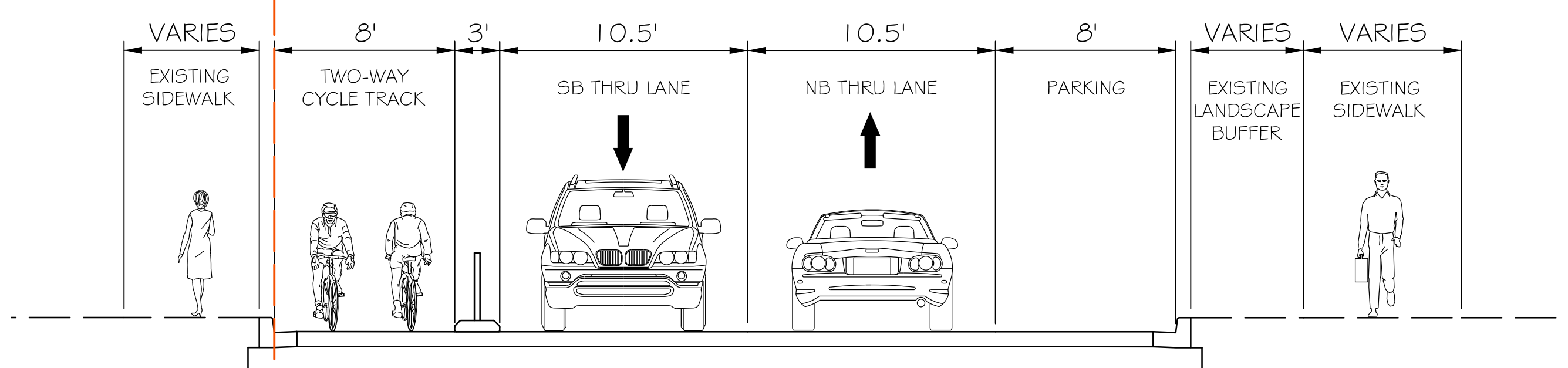
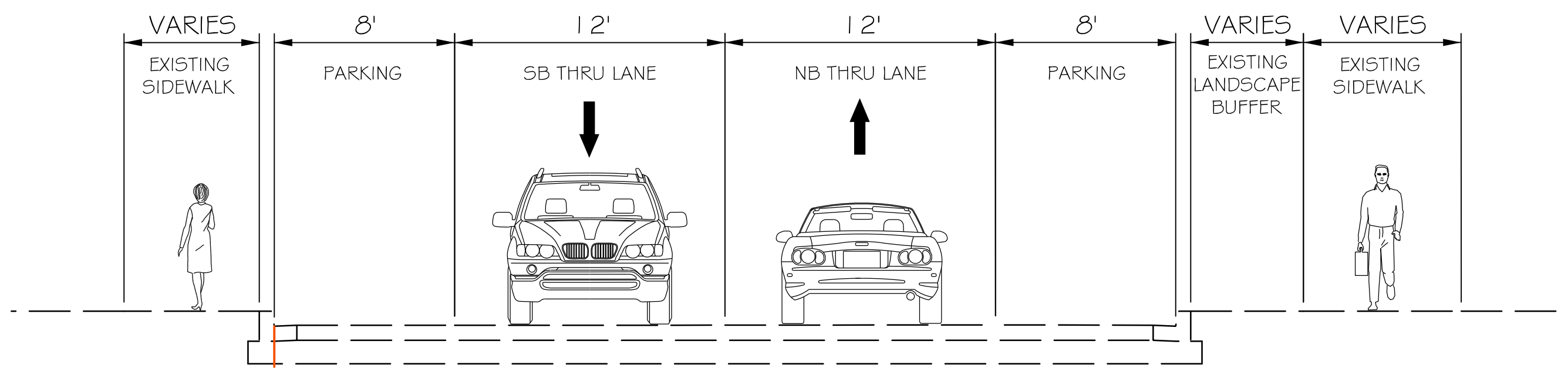

TYPICAL SECTIONS

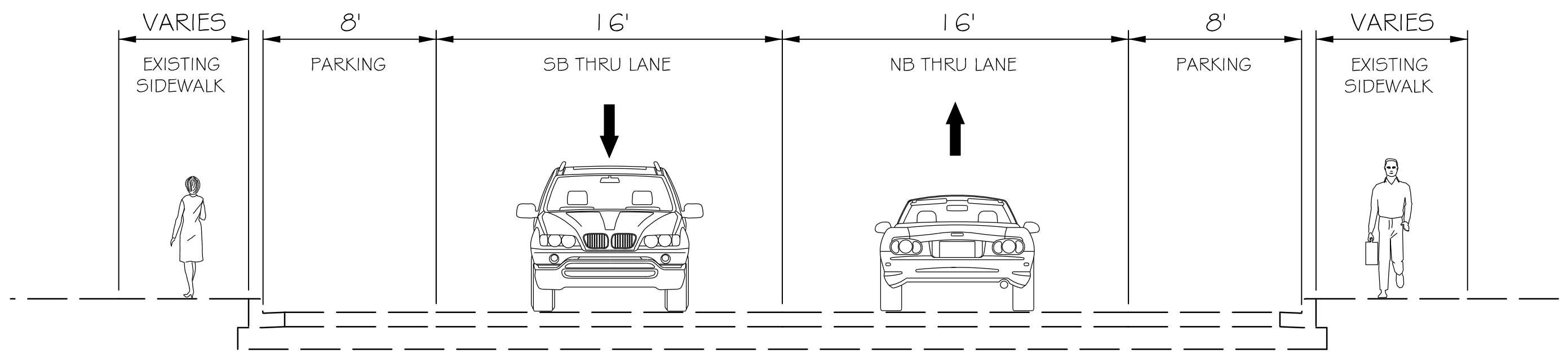

NORTH OF UNIVERSITY BOULEVARD (MD 193) TO BLUERIDGE AVENUE
EXISTING TYPICAL SECTION

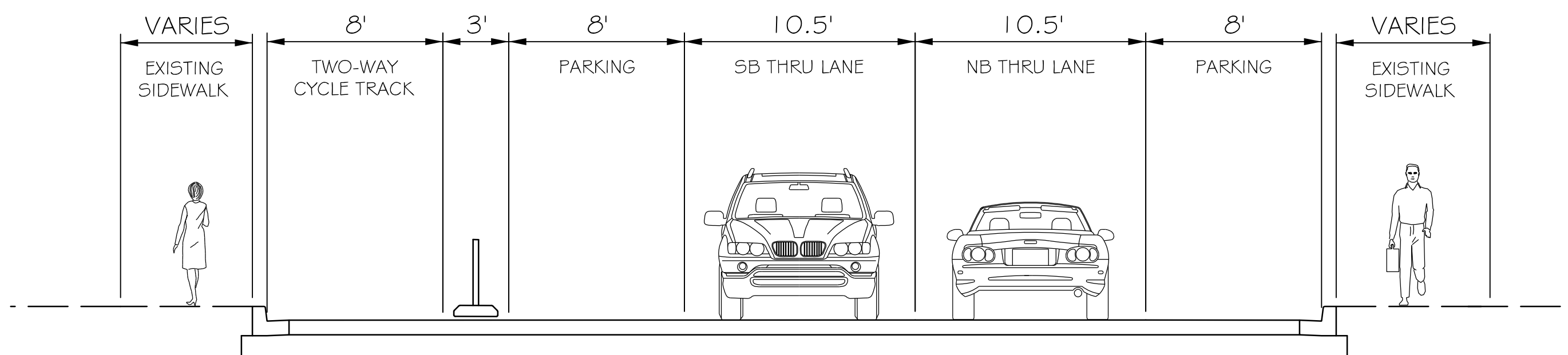

NORTH OF UNIVERSITY BOULEVARD (MD 193) TO BLUERIDGE AVENUE
PROPOSED TYPICAL SECTION

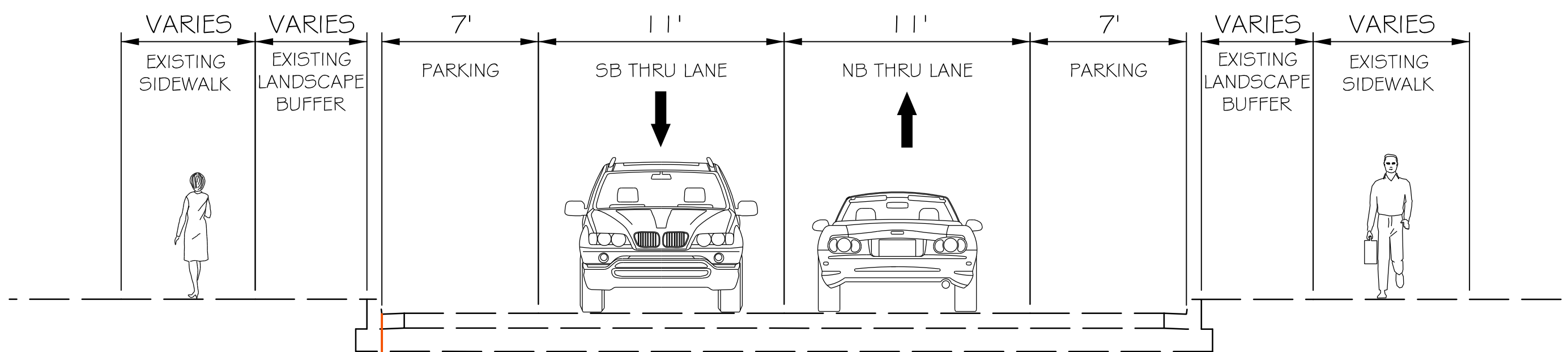

BLUERIDGE AVENUE TO ARCOLA AVENUE
EXISTING TYPICAL SECTION

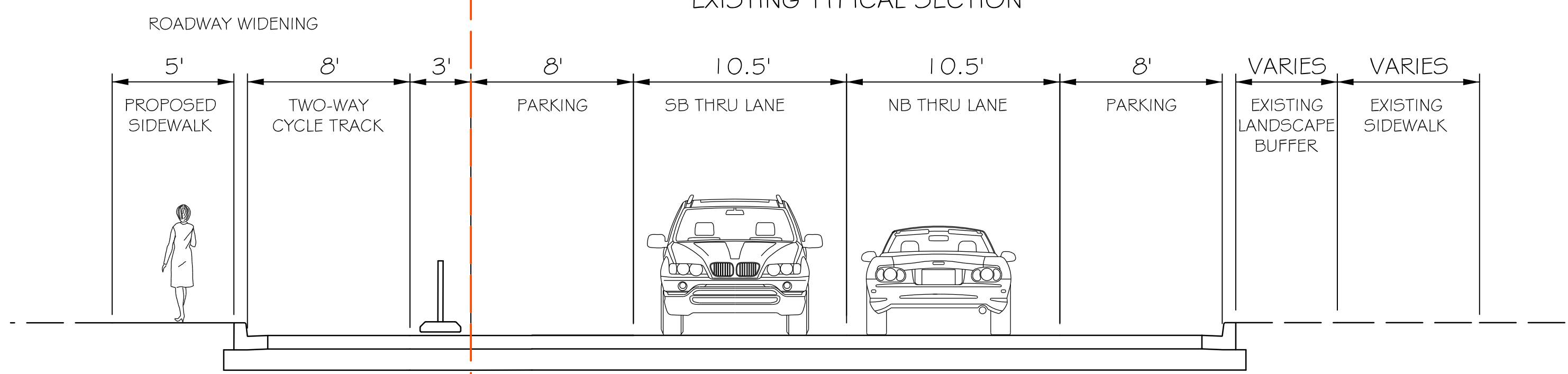

BLUERIDGE AVENUE TO ARCOLA AVENUE
PROPOSED TYPICAL SECTION